

## Dual-Channel (3-Phase CPU/1-Phase GPU) SVID, D-CAP+™ Step-Down Controller for IMVP-7 $V_{CORE}$ with Two Integrated Drivers

### FEATURES

- Intel IMVP-7 Serial VID (SVID) Compliant
- Supports CPU and GPU Outputs
- CPU Channel 1, 2, or 3 Phase
- Single-Phase GPU Channel
- Full IMVP-7 Mobile Feature Set Including Digital Current Monitor
- 8-Bit DAC with 0.250-V to 1.52-V Output Range
- Optimized Efficiency at Light and Heavy Loads
- $V_{CORE}$  Overshoot Reduction (OSR)
- $V_{CORE}$  Undershoot Reduction (USR)
- Accurate, Adjustable Voltage Positioning
- 8 Independent Frequency Selections per Channel (CPU/GPU)
- Patent Pending AutoBalance™ Phase Balancing
- Selectable 8-Level Current Limit
- 3-V to 28-V Conversion Voltage Range
- Two Integrated Fast FET Drivers w/Integrated Boost FET
- Internal Driver Bypass Mode for Use with DrMOS Devices
- Small 6 × 6, 48-Pin, QFN, PowerPAD™ Package

### DESCRIPTION

The TPS51640A, TPS59640 and TPS59641 are dual-channel, fully SVID compliant IMVP-7 step-down controllers with two integrated gate drivers. Advanced control features such as D-CAP+™ architecture with overlapping pulse support (undershoot reduction, USR) and overshoot reduction (OSR) provide fast transient response, lowest output capacitance and high efficiency. All of these controllers also support single-phase operation for light loads. The full compliment of IMVP-7 I/O is integrated into the controllers including dual PGOOD signals,  $\overline{ALERT}$  and  $\overline{VR\_HOT}$ . Adjustable control of  $V_{CORE}$  slew rate and voltage positioning round out the IMVP-7 features. In addition, the controllers' CPU channel includes two high-current FET gate drivers to drive high-side and low-side N-channel FETs with exceptionally high speed and low switching loss. The TPS51601 or TPS51601A driver is used for the third phase of the CPU and the GPU channel.

The BOOT voltage ( $V_{BOOT}$ ) on the TPS51640A and TPS59640 is 0 V. The TPS59641 is specifically designed for a  $V_{BOOT}$  level of 1.1 V.

These controllers are packaged in a space saving, thermally enhanced 48-pin QFN. The TPS51640A is rated to operate from  $-10^{\circ}\text{C}$  to  $105^{\circ}\text{C}$ . The TPS59640 and TPS59641 are rated to operate from  $-40^{\circ}\text{C}$  to  $105^{\circ}\text{C}$ .

### APPLICATIONS

- IMVP-7  $V_{CORE}$  Applications for Adapter, Battery, NVDC or 3 V/5 V/12 V rails

### SIMPLIFIED APPLICATION

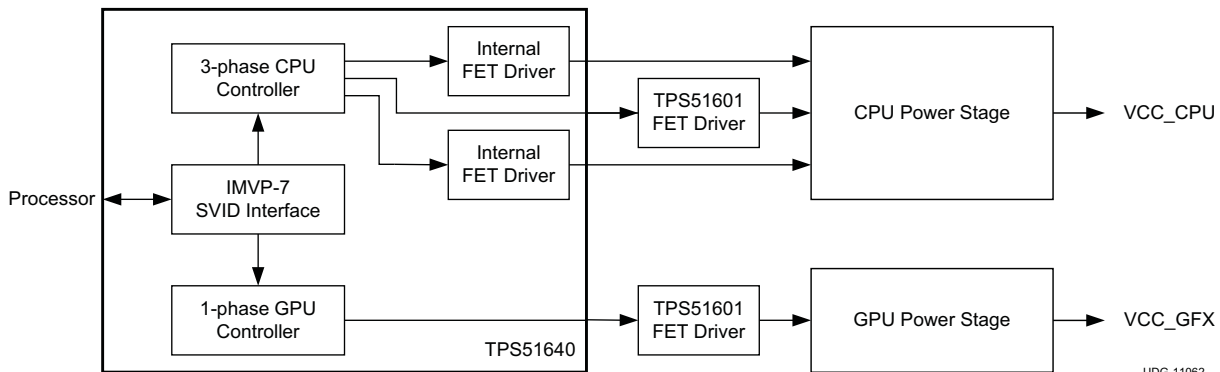

UDG-11062



Please be aware that an important notice concerning availability, standard warranty, and use in critical applications of Texas Instruments semiconductor products and disclaimers thereto appears at the end of this data sheet.

D-CAP+, PowerPAD, D-CAP are trademarks of Texas Instruments.

# TPS51640A, TPS59640, TPS59641

SLUSAQ2 – JANUARY 2012

[www.ti.com](http://www.ti.com)

These devices have limited built-in ESD protection. The leads should be shorted together or the device placed in conductive foam during storage or handling to prevent electrostatic damage to the MOS gates.

## ORDERING INFORMATION<sup>(1)(2)</sup>

T <sub>A</sub>	PACKAGE	V <sub>BOOT</sub> (V)	ORDERABLE NUMBER	PINS	TRANSPORT MEDIA	MINIMUM QUANTITY	ECO PLAN
-10°C to 105°C	Plastic Quad Flat Pack (QFN)	0	TPS51640ARSLT	48	Tape-and-reel	250	Green (RoHS and no Sb/Br)
			TPS51640ARSLR			2500	
-40°C to 105°C		0	TPS59640RSLT			250	
			TPS59640RSLR			2500	
		1.1	TPS59641RSLT <sup>(3)</sup>			250	
			TPS59641RSLTR <sup>(3)</sup>			2500	

- (1) For the most current package and ordering information see the *Package Option Addendum* at the end of this document, or see the TI web site at [www.ti.com](http://www.ti.com).
- (2) Package drawings, thermal data, and symbolization are available at [www.ti.com/packaging](http://www.ti.com/packaging).
- (3) Product preview. Not currently available.

## ABSOLUTE MAXIMUM RATINGS<sup>(1)(2)</sup>

over operating free-air temperature range (unless otherwise noted)

		MIN	TYP	MAX	UNIT
Input voltage	V <sub>BAT</sub>	-0.3		32	
	CSW1, CSW2	-6.0		32	V
	CDH1 to CSW1; CDH2 to CSW2; CBST1 to CSW1; CBST2 to CSW2	-0.3		6.0	V
	CTHERM, CCOMP, CF-IMAX, GF-IMAX, GCOMP, G THERM, V5DRV, V5	-0.3		6.0	
	COCP-I, CCSP1, CCSP2, CCSP3, CCSN1, CCSN2, CCSN3, CVFB, CGFB, V3R3, VR_ON, VCLK, VDIO, SLEWA, GGFB, GVFB, GCSN, GCSP, GOCP-I,	-0.3		3.6	
	PGND	-0.3		0.3	
Output voltage	VREF	-0.3		1.8	V
	CPGOOD, ALERT, VR_HOT, GPGOOD, CIMON, GIMON	-0.3		3.6	
	CPWM3, CSKIP, GPWM, GSKIP, CDL1, CDL2	-0.3		6.0	
Electrostatic discharge	(HBM) QSS 009-105 (JESD22-A114A)	1.5			kV
	(CDM) QSS 009-147 (JESD22-C101B.01)	500			V
Operating junction temperature, T <sub>J</sub>		-40		125	°C
Storage temperature, T <sub>stg</sub>		-55		150	°C

- (1) Stresses beyond those listed under absolute maximum ratings may cause permanent damage to the device. These are stress ratings only and functional operation of the device at these or any other conditions beyond those indicated under recommended operating conditions is not implied. Exposure to absolute-maximum-rated conditions for extended periods may affect device reliability.
- (2) All voltage values are with respect to the network ground terminal unless otherwise noted.

**THERMAL INFORMATION**

THERMAL METRIC <sup>(1)</sup>		TPS51640A TPS59640 TPS59641	UNITS
		RSL 48 PINS	
$\theta_{JA}$	Junction-to-ambient thermal resistance	31.7	°C/W
$\theta_{JTop}$	Junction-to-case (top) thermal resistance	19.8	
$\theta_{JB}$	Junction-to-board thermal resistance	7.1	
$\Psi_{JT}$	Junction-to-top characterization parameter	0.3	
$\Psi_{JB}$	Junction-to-board characterization parameter	7.1	
$\theta_{JBot}$	Junction-to-case (bottom) thermal resistance	2.1	

(1) For more information about traditional and new thermal metrics, see the *IC Package Thermal Metrics* application report, [SPRA953](#).

**RECOMMENDED OPERATING CONDITIONS**

		MIN	TYP	MAX	UNIT
Input voltage	VBAT	-0.1		28	V
	CSW1, CSW2	-3.0		30	
	CDH1 to CSW1; CDH2 to CSW2; CBST1 to CSW1; CBST2 to CSW2	-0.1		5.5	
	V5DRV, V5	4.5		5.5	
	V3R3	3.1		3.5	
	CCOMP, GCOMP	-0.1		2.5	
	CTHERM, G THERM	0.1		3.6	
	CF-IMAX, GF-IMAX, COCP-I, GOCP-I	0.1		1.7	
	CCSP1, CCSP2, CCSP3, CCSN1, CCSN2, CCSN3, CVFB, CGFB, GGFB, GVFB, GCSN, GCSP,	-0.1		1.7	
	VR_ON, VCLK, VDIO, SLEWA,	-0.1		3.5	
PGND	-0.1		0.1		
Output voltage	VREF	-0.1		1.72	V
	CIMON, GIMON	-0.1		$V_{VREF}$	
	CPGOOD, $\overline{ALERT}$ , $\overline{VR\_HOT}$ , GPGOOD,	-0.1		$V_{V3R3}$	
	CPWM3, CSKIP, GPWM, $\overline{GSKIP}$ , CDL1, CDL2,	-0.1		$V_{V5}$	
Operating free air temperature, $T_A$	TPS51460A	-10		105	°C
	TPS59640, TPS59641	-40		105	

**ELECTRICAL CHARACTERISTICS**

 over recommended free-air temperature range,  $V_{V5} = V_{V5DRV} = 5.0\text{ V}$ ;  $V_{V3R3} = 3.3\text{ V}$ ;  $V_{xGFB} = V_{PGND} = V_{GND}$ ,  $V_{xVFB} = V_{CORE}$   
 (Unless otherwise noted)

PARAMETER		TEST CONDITIONS	MIN	TYP	MAX	UNIT
<b>SUPPLY: CURRENTS, UVLO AND POWER-ON RESET</b>						
$I_{V5-4}$	V5 supply current CPU: 3-phase active GPU: 1-phase active	$I_{V5} + I_{V5DRV}$ , $V_{VDAC} < V_{xVFB} < (V_{VDAC} + 100\text{ mV})$ , $VR\_ON = 'HI'$		6.0	9.0	mA
$I_{V5-3}$	V5 supply current CPU: 2-phase active GPU: 1-phase active	$I_{V5} + I_{V5DRV}$ , $V_{VDAC} < V_{xVFB} < (V_{VDAC} + 100\text{ mV})$ , $VR\_ON = 'HI'$ , $V_{CCSP3} = 3.3\text{ V}$		5.5		mA
$I_{V5-2}$	V5 supply current CPU: 1-phase active GPU: 1-phase active	$I_{V5} + I_{V5DRV}$ , $V_{VDAC} < V_{xVFB} < (V_{VDAC} + 100\text{ mV})$ , $VR\_ON = 'HI'$ , $V_{CCSP3} = V_{CCSP2} = 3.3\text{ V}$		4.9		mA
$I_{V5-PS3}$	V5 supply current CPU: 3-phase active GPU: 1-phase active	$I_{V5} + I_{V5DRV}$ , $V_{VDAC} < V_{xVFB} < (V_{VDAC} + 100\text{ mV})$ , $VR\_ON = 'HI'$ , $SetPS = PS3$ (Note: 3-phase CPU goes to 1-phase in PS3)		5.1		mA
$I_{V5STBY}$	V5DRV standby current	$VR\_ON = 'LO'$ , $I_{V5} + I_{V5DRV}$		10	20	$\mu\text{A}$
$V_{UVLOH}$	V5 UVLO 'OK' Threshold	Ramp up, $VR\_ON = 'HI'$ ,	4.25	4.4	4.5	V
$V_{UVLOL}$	V5 UVLO fault threshold	Ramp down, $VR\_ON = 'HI'$ ,	3.95	4.2	4.3	V
$I_{V3R3}$	V3R3 supply current	SVID bus idle, $VR\_ON = 'HI'$		0.5	1.0	mA
$I_{V3R3SBY}$	V3R3 standby current	$VR\_ON = 'LO'$			10	$\mu\text{A}$
$V_{3UVLOH}$	V3R3 UVLO 'OK' threshold	Ramp up, $VR\_ON = 'HI'$ ,	2.5	2.9	3.0	V
$V_{3UVLOL}$	V3R3 UVLO fault threshold	Ramp down, $VR\_ON = 'HI'$ ,	2.4	2.7	2.8	V
<b>REFERENCES: DAC, VREF, VBOOT AND DRVL DISCHARGE FOR BOTH CPU AND GPU</b>						
$V_{BOOT}$	Boot voltage	TPS59640 TPS51640A		0		V
		TPS59641		1.1		
$V_{VIDSTP}$	VID step size			5		mV
$V_{DAC1}$	xVFB tolerance no load active	$0.25 \leq V_{xVFB} \leq 0.995\text{ V}$ , $I_{xPU\_CORE} = 0\text{ A}$ , $0^\circ\text{C} \leq T_A \leq 85^\circ\text{C}$	TPS51640A	-5		5
		$0.25 \leq V_{xVFB} \leq 0.995\text{ V}$ , $I_{xPU\_CORE} = 0\text{ A}$ , $-40^\circ\text{C} \leq T_A \leq 105^\circ\text{C}$	TPS59640 TPS59641	-6		8.3
$V_{DAC4}$	xVFB tolerance above 1 V VID	$1.000\text{ V} \leq V_{xVFB} \leq 1.520\text{ V}$ , $I_{xPU\_CORE} = 0\text{ A}$ , $0^\circ\text{C} \leq T_A \leq 85^\circ\text{C}$	TPS51640A	-0.5%		0.5%
		$1.000\text{ V} \leq V_{xVFB} \leq 1.520\text{ V}$ , $I_{xPU\_CORE} = 0\text{ A}$ , $-40^\circ\text{C} \leq T_A \leq 105^\circ\text{C}$	TPS59640 TPS59641	-0.65%		1.0%
$V_{VREF}$	VREF Output	$4.5\text{ V} \leq V_{V5} \leq 5.5\text{ V}$ , $I_{VREF} = 0\text{ A}$		1.70		V
$V_{VREFSRC}$	VREF output source	$0\text{ }\mu\text{A} \leq I_{VREF} \leq 500\text{ }\mu\text{A}$	-4	-0.1		mV
$V_{VREFSNK}$	VREF output sink	$-500\text{ }\mu\text{A} \leq I_{VREF} \leq 0\text{ }\mu\text{A}$		0.1	4	mV
$V_{DLDQ}$	DRVL discharge threshold	Soft-stop transistor turns on at this point.		200	300	mV
<b>VOLTAGE SENSE: xVFB AND xGFB FOR BOTH CPU AND GPU</b>						
$I_{xVFB}$	xVFB input bias current	$V_{xVFB} = 2\text{ V}$ , $V_{xGFB} = 0\text{ V}$		20	40	$\mu\text{A}$
$I_{xGFB}$	xGFB input bias current	$V_{xVFB} = 2\text{ V}$ , $V_{xGFB} = 0\text{ V}$	-40	-20		$\mu\text{A}$
$A_{GAINGND}$	xGFB/GND gain			1		V/V
<b>CURRENT MONITOR</b>						
$V_{CIMONLK}$	Zero level current output	$\Sigma\Delta\text{CS} = 0\text{ mV}$ , $\text{AIMON} = 12 \times (1+1.27)$		35		mV
$V_{CIMONLO}$	Low level current output	$\Sigma\Delta\text{CS} = 15.6\text{ mV}$ , $\text{AIMON} = 12 \times (1+1.27)$		425		mV
$V_{CIMONMID}$	Mid level current output	$\Sigma\Delta\text{CS} = 31.1\text{ mV}$ , $\text{AIMON} = 12 \times (1+1.27)$		850		mV
$V_{CIMONHI}$	High level current output	$\Sigma\Delta\text{CS} = 62.3\text{ mV}$ , $\text{AIMON} = 12 \times (1+1.27)$		1700		mV
<b>ZERO-CROSSING</b>						
$V_{Zx}$	Inductor zero crossing threshold voltage			0		mV

**ELECTRICAL CHARACTERISTICS (continued)**

over recommended free-air temperature range,  $V_{V5} = V_{V5DRV} = 5.0$  V;  $V_{V3R3} = 3.3$  V;  $V_{xGFB} = V_{PGND} = V_{GND}$ ,  $V_{xVFB} = V_{CORE}$   
(Unless otherwise noted)

PARAMETER	TEST CONDITIONS	MIN	TYP	MAX	UNIT		
<b>CURRENT SENSE: OVERCURRENT, ZERO CROSSING, VOLTAGE POSITIONING AND PHASE BALANCING</b>							
$V_{OCP}$	OCP voltage (valley current limit)	$R_{xOCP-I} = 20$ k $\Omega$	TPS51640A	5.1	7.0	9.7	mV
			TPS59640 TPS59641	4.6	7.0	9.7	
		$R_{xOCP-I} = 24$ k $\Omega$	TPS51640A	8.1	10.0	12.6	
			TPS59640 TPS59641	7.6	10.0	13.1	
		$R_{xOCP-I} = 30$ k $\Omega$	TPS51640A	12.1	14.0	16.7	
			TPS59640 TPS59641	11.6	14.0	17.2	
		$R_{xOCP-I} = 39$ k $\Omega$	TPS51640A	17.1	19.0	21.7	
			TPS59640 TPS59641	16.6	19.0	22.2	
		$R_{xOCP-I} = 56$ k $\Omega$	TPS51640A	23.1	25.0	27.9	
			TPS59640 TPS59641	22.6	25.0	28.4	
		$R_{xOCP-I} = 75$ k $\Omega$	TPS51640A	29.7	32.0	35.0	
			TPS59640 TPS59641	29.2	32.0	35.5	
		$R_{xOCP-I} = 100$ k $\Omega$	TPS51640A	37.9	40.0	43.3	
			TPS59640 TPS59641	37.4	40.0	43.8	
$R_{xOCP-I} = 150$ k $\Omega$	TPS51640A	46.8	49.0	52.6			
	TPS59640 TPS59641	46.2	49.0	53.1			
$V_{IMAX}$	IMAX values both channels	$V_{IMAX\_MIN} = 133$ mV, value of xIMAX, $V_{IMAX} = V_{REF} \times I_{MAX} / 255$		20		A	
		$V_{IMAX\_MAX} = 653$ mV, value of xIMAX		98		A	
$I_{CS}$	CS pin input bias current	CSPx and CSNx		-1.0	0.2	1.0	$\mu$ A
$I_{xVFBdq}$	xVFB input bias current, discharge	End of soft-stop, xVFB = 100mV		90	125	180	$\mu$ A
$G_{M-DROOP}$	Droop amplifier transconductance	xVFB = 1 V	TPS51640A	486	497	518	$\mu$ S
			TPS59640 TPS59641	480	497	518	
$I_{BAL\_TOL}$	Internal current share tolerance	$(V_{CSP1} - V_{CSN1}) = (V_{CSP2} - V_{CSN2}) =$ $(V_{CSP3} - V_{CSN3}) = V_{OCP\_MIN}$		-3%		+3%	
$A_{CSINT}$	Internal current sense gain	Gain from CSPx – CSNx to PWM comparator		11.65	12.00	12.30	V/V

**TPS51640A, TPS59640, TPS59641**

SLUSAQ2–JANUARY 2012

[www.ti.com](http://www.ti.com)
**ELECTRICAL CHARACTERISTICS (continued)**

 over recommended free-air temperature range,  $V_{V5} = V_{V5DRV} = 5.0\text{ V}$ ;  $V_{V3R3} = 3.3\text{ V}$ ;  $V_{XGFB} = V_{PGND} = V_{GND}$ ,  $V_{xVFB} = V_{CORE}$   
 (Unless otherwise noted)

PARAMETER		TEST CONDITIONS	MIN	TYP	MAX	UNIT		
<b>TIMERS: SLEW RATE, ISLEW, ADDR, ON-TIME AND I/O TIMING</b>								
$t_{STARTUP1}$	Start-up time	$V_{BOOT} > 0\text{ V}$ , SLEWRATE = 12 mV/ $\mu$ s, no faults, time from VR_ON until the controller responds to SVID commands			5	ms		
SL_STRTSTP	xVFB slew soft-start / soft-stop	SLEWRATE = 12mV/ $\mu$ s, VR_ON goes 'HI', VR_ON goes 'LO = 'Soft-stop'	1.25	1.50	1.75	mV/ $\mu$ s		
SL_SET	Slew rate setting	$V_{SLEWA} \leq 0.30\text{V}$ (Also disables SVID CLK timer)	10.0	12.0	14.5	mV/ $\mu$ s		
		$V_{SLEWA} = 0.4\text{ V}$	3.5	4.0	5.0			
		$V_{SLEWA} = 0.6\text{ V}$	7.5	8.5	9.5			
		$0.75\text{ V} \leq V_{SLEWA} \leq 0.85\text{ V}$	10.0	12.0	14.5			
		$V_{SLEWA} = 1.0\text{ V}$		16				
		$V_{SLEWA} = 1.2\text{ V}$		20				
		$V_{SLEWA} = 1.4\text{ V}$		23				
		$V_{SLEWA} = 1.6\text{ V}$		26				
$V_{SLEWA} \geq 2.50\text{ V}$			26					
$t_{PGDDGLTO}$	xPGOOD deglitch time	Time from xVFB out of +220 mV VDAC boundary to xPGOOD low.		5	100	$\mu$ s		
$t_{PGDDGLTU}$	xPGOOD deglitch time	Time from xVFB out of -315 mV VDAC boundary to xPGOOD low.		150	500	$\mu$ s		
$t_{TON\_CPU}$	CPU on-time	$R_{CF}=20\text{ k}\Omega$ , $V_{BAT}=12\text{ V}$ , $V_{DAC}=1.1\text{ V}$ (250 kHz)	TPS51640A	270	327	375	ns	
			TPS59640 TPS59641	265	327	380		
		$R_{CF}=24\text{ k}\Omega$ , $V_{BAT}=12\text{ V}$ , $V_{DAC}=1.1\text{ V}$ (300 kHz)	TPS51640A	225	272	320		
			TPS59640 TPS59641	220	272	325		
		$R_{CF}=30\text{ k}\Omega$ , $V_{BAT}=12\text{ V}$ , $V_{DAC}=1.1\text{ V}$ (350 kHz)	TPS51640A	185	235	280		
			TPS59640 TPS59641	180	235	285		
		$R_{CF}=39\text{ k}\Omega$ , $V_{BAT}=12\text{ V}$ , $V_{DAC}=1.1\text{ V}$ (400 kHz)	TPS51640A	160	207	252		
			TPS59640 TPS59641	155	207	262		
		$R_{CF}=56\text{ k}\Omega$ , $V_{BAT}=12\text{ V}$ , $V_{DAC}=1.1\text{ V}$ (450 kHz)	TPS51640A	140	185	231		
			TPS59640 TPS59641	134	185	241		
		$R_{CF}=75\text{ k}\Omega$ , $V_{BAT}=12\text{ V}$ , $V_{DAC}=1.1\text{ V}$ (500 kHz)	TPS51640A	120	167	212		
			TPS59640 TPS59641	115	167	217		
		$R_{CF}=100\text{ k}\Omega$ , $V_{BAT}=12\text{ V}$ , $V_{DAC}=1.1\text{ V}$ (550 kHz)			109	152		198
		$R_{CF}=150\text{ k}\Omega$ , $V_{BAT}=12\text{ V}$ , $V_{DAC}=1.1\text{ V}$ (600 kHz)			105	140		177

**ELECTRICAL CHARACTERISTICS (continued)**

over recommended free-air temperature range,  $V_{V5} = V_{V5DRV} = 5.0\text{ V}$ ;  $V_{V3R3} = 3.3\text{ V}$ ;  $V_{xGFB} = V_{PGND} = V_{GND}$ ,  $V_{xVFB} = V_{CORE}$   
(Unless otherwise noted)

PARAMETER	TEST CONDITIONS	MIN	TYP	MAX	UNIT	
<b>TIMERS: SLEW RATE, ISLEW, ADDR, ON-TIME AND I/O TIMING (Continued)</b>						
$t_{TON\_GPU}$ GPU on-time	$R_{GF}=20\text{ k}\Omega$ , $V_{BAT}=12\text{ V}$ , $V_{DAC}=1.1\text{ V}$ (275 kHz)	TPS51640A	315	347	388	ns
		TPS59640 TPS59641	310	347	393	
	$R_{GF}=24\text{ k}\Omega$ , $V_{BAT}=12\text{ V}$ , $V_{DAC}=1.1\text{ V}$ (330 kHz)	TPS51640A	251	287	330	
		TPS59640 TPS59641	246	287	335	
	$R_{GF}=30\text{ k}\Omega$ , $V_{BAT}=12\text{ V}$ , $V_{DAC}=1.1\text{ V}$ (385 kHz)	TPS51640A	215	245	287	
		TPS59640 TPS59641	210	245	292	
	$R_{GF}=39\text{ k}\Omega$ , $V_{BAT}=12\text{ V}$ , $V_{DAC}=1.1\text{ V}$ (440 kHz)	TPS51640A	180	216	252	
		TPS59640 TPS59641	175	216	257	
	$R_{GF}=56\text{ k}\Omega$ , $V_{BAT}=12\text{ V}$ , $V_{DAC}=1.1\text{ V}$ (495 kHz)	TPS51640A	160	190	223	
		TPS59640 TPS59641	155	190	228	
$R_{GF}=75\text{ k}\Omega$ , $V_{BAT}=12\text{ V}$ , $V_{DAC}=1.1\text{ V}$ (550 kHz)		145	171	210		
$R_{GF}=100\text{ k}\Omega$ , $V_{BAT}=12\text{ V}$ , $V_{DAC}=1.1\text{ V}$ (605 kHz)		120	156	205		
$R_{GF}=150\text{ k}\Omega$ , $V_{BAT}=12\text{ V}$ , $V_{DAC}=1.1\text{ V}$ (660 kHz)		100	150	201		
$t_{MIN}$ Controller minimum off time	Fixed value		150	200	ns	
$t_{VCCVID}$ VID change to xVFB change <sup>(1)</sup>	ACK of SetVID-x command to start of voltage ramp			2	$\mu\text{s}$	
$t_{VRONPGD}$ VR_ON low to xPGOOD low		20	50	100	ns	
$t_{PGDVCC}$ xPGOOD low to xVFB change <sup>(1)</sup>				100	ns	
$t_{VRTDGLT}$ VR_HOT# deglitch time			0.2	0.7	ms	
$R_{SFTSTP}$ Soft-stop transistor resistance	Connect to CVFB, GVFB	550	770	1100	$\Omega$	
<b>PROTECTION: OVP, UVP PGOOD, <math>\overline{VR\_HOT}</math>, 'FAULTS OFF' AND INTERNAL THERMAL SHUTDOWN</b>						
$V_{OVPH}$ Fixed OVP voltage threshold voltage	$V_{CSN1}$ or $V_{GCSN} > V_{OVPH}$ for 1 $\mu\text{s}$ , $DRV_L \rightarrow ON$	1.68	1.72	1.77	V	
$V_{PGDH}$ xPGOOD high threshold	Measured at the xVFB pin wrt/VID code, device latches OFF	190	220	245	mV	
$V_{PGDL}$ xPGOOD low threshold	Measured at the xVFB pin wrt/VID code, device latches OFF	-348	-315	-280	mV	
$V_{THERM}$ IMVP-7 thermal bit voltage definition	bit0 of xTHERM register = high	757	783	808	mV	
	bit1 of xTHERM register also is high	651	680	707		
	bit2 of xTHERM register also is high	611	638	663		
	bit3 of xTHERM register also is high	570	598	623		
	bit4 of xTHERM register also is high	531	559	583		
	bit5 of xTHERM register also is high	496	523	548		
	bit6 of xTHERM register also is high, ALERT goes low	461	488	513		
	bit7 of XTHERM register also is high, VR_HOT goes low	428	455	481		
$I_{THERM}$ THERM current	Leakage current	-5		5	$\mu\text{A}$	
$TH_{INT}$ Internal controller thermal Shutdown <sup>(1)</sup>	Latch off controller		155		$^{\circ}\text{C}$	
$TH_{HYS}$ Controller thermal SD hysteresis <sup>(1)</sup>	Cooling required before converter can be reset		20		$^{\circ}\text{C}$	

(1) Specified by design. Not production tested.

**ELECTRICAL CHARACTERISTICS (continued)**

 over recommended free-air temperature range,  $V_{V5} = V_{V5DRV} = 5.0\text{ V}$ ;  $V_{V3R3} = 3.3\text{ V}$ ;  $V_{XGFB} = V_{PGND} = V_{GND}$ ,  $V_{XVFB} = V_{CORE}$   
 (Unless otherwise noted)

PARAMETER		TEST CONDITIONS	MIN	TYP	MAX	UNIT
<b>LOGIC (VCLK, VDIO, ALERT, VR_HOT, VR_ON) INTERFACE PINS: I/O VOLTAGE AND CURRENT</b>						
R <sub>RSVIDL</sub>	Open drain pull down resistance	VDIO, ALERT, VR_HOT, pull-down resistance at 0.31 V	4	8	13	Ω
R <sub>RPGD</sub>	Open drain pull down resistance	xPGOOD pull-down resistance at 0.31 V		36	50	
I <sub>VRTTLK</sub>	Open drain leakage current	VR_HOT, xPGOOD, Hi-Z leakage, apply 3.3-V in off state	-2	0.2	2	μA
V <sub>IL</sub>	Input logic low	VCLK, VDIO			0.45	V
V <sub>IH</sub>	Input logic high		0.65			V
V <sub>HYST</sub>	Hysteresis voltage <sup>(1)</sup>			0.05		V
V <sub>VR_ONL</sub>	VR_ON logic low				0.3	V
V <sub>VR_ONH</sub>	VR_ON logic high		0.8			V
I <sub>VR_ONH</sub>	I/O 3.3 V leakage	Leakage current, V <sub>VR_ON</sub> = 1.1 V	10		25.0	μA
<b>OVERSHOOT AND UNDERSHOOT REDUCTION (OSR/USR) THRESHOLD SETTING</b>						
V <sub>OSR</sub>	OSR voltage set	R <sub>xSKIP</sub> = 20 kΩ			106	mV
		R <sub>xSKIP</sub> = 24 kΩ			156	
		R <sub>xSKIP</sub> = 30 kΩ			207	
		R <sub>xSKIP</sub> = 39 kΩ			257	
		R <sub>xSKIP</sub> = 56 kΩ			308	
		R <sub>xSKIP</sub> = 75 kΩ			409	
		R <sub>xSKIP</sub> = 100 kΩ			510	
		R <sub>xSKIP</sub> = 150 kΩ			610	
V <sub>USR</sub>	USR voltage set	R <sub>xSKIP</sub> = 20 kΩ			40	mV
		R <sub>xSKIP</sub> = 24 kΩ			60	
		R <sub>xSKIP</sub> = 30 kΩ			75	
		R <sub>xSKIP</sub> = 39 kΩ			115	
		R <sub>xSKIP</sub> = 56 kΩ			153	
		R <sub>xSKIP</sub> = 75 kΩ			190	
		R <sub>xSKIP</sub> = 100 kΩ			230	
		R <sub>xSKIP</sub> ≥ 150 kΩ = OFF			–	
V <sub>OSR_OFF</sub>	OSR OFF setting	V <sub>xSKIP</sub> at start up	100		300	mV
V <sub>OSRHYS</sub>	OSR/USR voltage hysteresis <sup>(2)</sup>	All settings		20%		

(2) Specified by design. Not production tested.



**ELECTRICAL CHARACTERISTICS (continued)**

over recommended free-air temperature range,  $V_{V5} = V_{V5DRV} = 5.0\text{ V}$ ;  $V_{V3R3} = 3.3\text{ V}$ ;  $V_{XGFB} = V_{PGND} = V_{GND}$ ,  $V_{XVFB} = V_{CORE}$   
(Unless otherwise noted)

PARAMETER		TEST CONDITIONS	MIN	TYP	MAX	UNIT
<b>DRIVERS: HIGH-SIDE, LOW-SIDE, CROSS CONDUCTION PREVENTION AND BOOST RECTIFIER</b>						
$R_{DRVH}$	DRVH ON resistance	$(V_{CBSTx} - V_{CSWx}) = 5\text{ V}$ , 'HI' state, $(V_{VBST} - V_{VDRVH}) = 0.25\text{ V}$		1.2	2.5	$\Omega$
		$(V_{CBSTx} - V_{CSWx}) = 5\text{ V}$ , 'LO' state, $(V_{DRVH} - V_{LL}) = 0.25\text{ V}$		0.8	2.5	
$I_{DRVH}$	DRVH sink/source current <sup>(3)</sup>	$V_{CDHx} = 2.5\text{ V}$ , $(V_{CBSTx} - V_{CSWx}) = 5\text{ V}$ , Source		2.2		A
		$V_{CDHx} = 2.5\text{ V}$ , $(V_{CBSTx} - V_{CSWx}) = 5\text{ V}$ , Sink		2.2		A
$t_{DRVH}$	DRVH transition time	CDHx 10% to 90% or 90% to 10%, $C_{CDHx} = 3\text{ nF}$		15	40	ns
				15	40	ns
$R_{DRVL}$	DRVL ON resistance	'HI' State, $(V_{V5DRV} - V_{VDRVL}) = 0.25\text{ V}$		0.9	2	$\Omega$
		'LO' State, $(V_{VDRVL} - V_{PGND}) = 0.2\text{ V}$		0.4	1	
$I_{DRVL}$	DRVL sink/source current <sup>(3)</sup>	$V_{CDLx} = 2.5\text{ V}$ , Source		2.7		A
		$V_{CDLx} = 2.5\text{ V}$ , Sink		6		A
$t_{DRVL}$	DRVL transition time	$V_{CDLx}$ 90% to 10%, $C_{CDLx} = 3\text{ nF}$		15	40	ns
		$V_{CDLx}$ 10% to 90%, $C_{CDLx} = 3\text{ nF}$		15	40	
$t_{NONOVL P}$	Driver non overlap time	$V_{CSWx}$ falls to 1 V to $V_{CDLx}$ rises to 1 V	13	25		ns
		CDLx falls to 1 V to CDHx rises to 1 V	13	25		
$R_{DS(on)}$	BST on-resistance	$(V_{V5DRV} - V_{VBST})$ , $I_F = 5\text{ mA}$	5	10	20	$\Omega$
$I_{BSTLK}$	BST switch leakage current	$V_{VBST} = 34\text{ V}$ , $V_{CSWx} = 28\text{ V}$		0.1	1	$\mu\text{A}$
<b>PWM and SKIP OUTPUT: I/O Voltage and Current</b>						
$V_{PWML}$	xPwMy output low level				0.7	V
$V_{PwMH}$	xPwMy output high level		4.2			V
$V_{SKIPL}$	SKIP output low level				0.7	V
$V_{SKIP H}$	SKIP output high level		4.2			V
$V_{PW(leak)}$	xPWM leakage	Tri-state, $V = 5\text{ V}$			0.1	$\mu\text{A}$

(3) Specified by design. Not production tested.

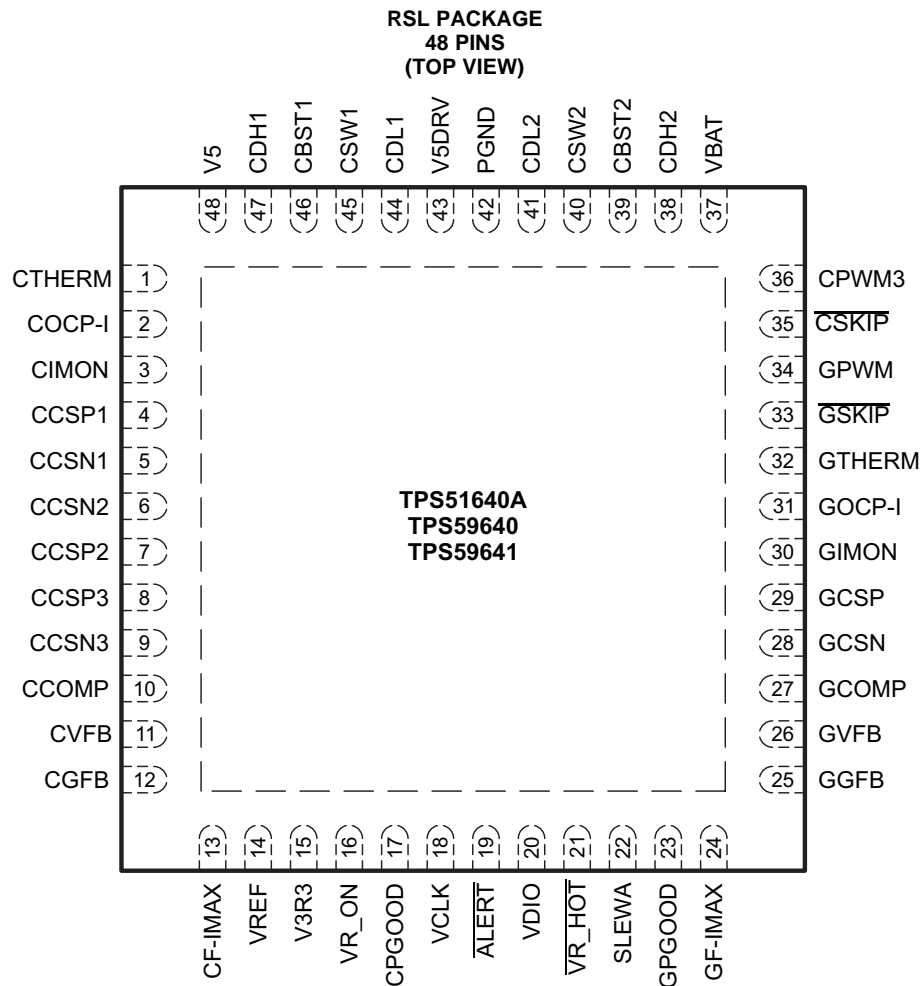
**DEVICE INFORMATION**

**PIN FUNCTIONS**

PIN		I/O	DESCRIPTION
NAME	NO.		
$\overline{\text{ALERT}}$	19	O	SVID interrupt line, open drain. Route between VCLK and VDIO to prevent cross-talk.
CBST1	46	I	Top N-channel FET bootstrap voltage input for CPU phase 1.
CBST2	39	I	Top N-channel bootstrap voltage input for CPU phase 2.
CCSN1	5	I	Negative current sense inputs for the CPU converter. Connect to the most negative node of current sense resistor or inductor DCR sense network. CCSN1 has a secondary OVP comparator.
CCSN2	6		
CCSN3	9		
CCOMP	10	O	Output of GM error amplifier for the CPU converter. A resistor to VREF sets the droop gain.
CCSP1	4	I	Positive current sense inputs for the CPU converter. Connect to the most positive node of current sense resistor or inductor DCR sense network. Tie CCSP3, 2 or 1 (in that order) to V3R3 to disable the phase. Tie CCSP1 to V3R3 to run the GPU converter only.
CCSP2	7		
CCSP3	8		
CDH1	47	O	Top N-channel FET gate drive output for CPU phase 1.
CDH2	38	O	Top N-channel FET gate drive output for CPU phase 2.
CDL1	44	O	Synchronous N-channel FET gate drive output for CPU phase 1.
CDL2	41	O	Synchronous N-channel FET gate drive output for CPU phase 2.

PIN		I/O	DESCRIPTION
NAME	NO.		
CF-IMAX	13	I	Voltage divider to VREF. A resistor to GND sets the operating frequency of the CPU converter. The voltage level sets the maximum operating current of the CPU converter. The IMAX value is an 8-bit A/D where $V_{IMAX} = V_{REF} \times I_{MAX} / 255$ . Both are latched at start-up.
CGFB	12	I	Voltage sense return tied for the CPU converter. Tie to GND with a 10-Ω resistor to close feedback when the microprocessor is not in the socket.
CIMON	3	O	Analog current monitor output for the CPU converter. $V_{CIMON} = \Sigma V_{CS} \times ACS \times (1 + R_{CIMON}/R_{COCP})$ . Connect a 220-nF capacitor to GND for stability.
COCP-I	2	I	Resistor to GND ( $R_{COCP}$ ) selects 1 of 8 OCP levels (per phase, latched at start-up) of the CPU converter. Also, voltage divider to CIMON. Resistor ratio sets the IMON gain (see CIMON pin description).
CPGOOD	17	O	IMVP-7_PWRGD output for the CPU converter. Open-drain.
CSW1	45	I/O	Top N-channel FET gate drive return for CPU phase 1.
CSW2	40	I/O	Top N-channel FET gate drive return for CPU phase 2.
CPWM3	36	O	PWM control for the external driver, 5V logic level.
$\overline{CSKIP}$	35	O	Skip mode control of the external driver for the CPU converter. A logic HI = FCCM, LO = SKIP. R to GND selects 1 of 8 OSR/USR levels. $0.1\text{ V} < V_{CSKIP} < 0.3\text{ V}$ at start-up turns OSR off.
CTHERM	1	I/O	Thermal sensor connection for the CPU converter. A resistor connected to VREF forms a divider with an NTC thermistor connected to GND.
CVFB	11	I	Voltage sense line tied directly to $V_{CORE}$ of the CPU converter. Tie to $V_{CORE}$ with a 10-Ω resistor to close feedback when $\mu P$ is not in the socket. The soft-stop transistor is on this pin
GCSN	28	I	Negative current sense input for the GPU converter. Connect to the most negative node of current sense resistor or inductor DCR sense network. GCSN has a secondary OVP comparator and includes the soft-stop pull-down transistor.
GCSP	29	I	Positive current sense input for the GPU converter. Connect to the most positive node of current sense resistor or inductor DCR sense network. Tie to V3R3 to disable the GPU converter.
GCOMP	27	O	Output of $g_m$ error amplifier for the GPU converter. A resistor to VREF sets the droop gain.
GGFB	25	I	Voltage sense return tied for the GPU converter. Tie to GND with a 10-Ω resistor to close feedback when the microprocessor is not in the socket.
GF-IMAX	24	I	Voltage divider to VREF. R to GND sets the operating frequency of the GPU converter. The voltage level sets the maximum operating current of the GPU converter. The IMAX value is an 8-bit A/D where $V_{IMAX} = V_{REF} \times I_{MAX} / 255$ . Both are latched at start-up.
GIMON	30	O	Analog current monitor output for the GPU converter. $V_{GIMON} = V_{ISENSE} \times (1 + R_{GIMON}/R_{GOCP})$ . Connect a 220-nF capacitor to GND for stability.
GOCP-I	31	I	Voltage divider to GIMON. Resistor ratio sets the IMON gain (see GIMON pin). Resistor to GND ( $R_{GOCP}$ ) selects 1 of 8 OCP levels (per phase, latched at start-up) of the GPU converter.
GPGOOD	23	O	IMVP-7_PWRGD output for the GPU converter. Open-drain.
GPWM	34	O	PWM control for the external driver, 5-V logic level.
$\overline{GSKIP}$	33	O	Skip mode control of the external driver for the GPU converter, 5-V logic level. Logic HI = FCCM, LO = SKIP. R to GND selects 1 of 8 OSR/USR levels. $0.1\text{ V} < V_{GSKIP} < 0.3\text{ V}$ at start-up turns OSR off.
G THERM	32	I/O	Thermal sensor input for the GPU converter. A resistor connected to VREF forms a divider with an NTC thermistor connected to GND.
GVFB	26	I	Voltage sense line tied directly to $V_{GFX}$ of the GPU converter. Tie to $V_{GFX}$ with a 10-Ω resistor to close feedback when the microprocessor is not in the socket. The soft-stop transistor is on this pin
PGND	42	–	Synchronous N-channel FET gate drive return.
SLEWA	22	I	The voltage at start-up sets 1 of 7 slew rates for both converters. The SLOW rate is SLEWRATE/4. Soft-start and soft-stop rates are SLEWRATE/8. This value is latched at start-up. Tie to GND to disable SCLK timer.
V5	48	I	5-V power input for analog circuits; connect through resistor to 5-V plane and bypass to GND with $\geq 1\ \mu\text{F}$ ceramic capacitor
V5DRV	43	I	Power input for the gate drivers; connected with an external resistor to V5F; decouple with a $\geq 2.2\ \mu\text{F}$ ceramic capacitor.
V3R3	15	I	3.3-V power input; bypass to GND with $\geq 1\ \mu\text{F}$ ceramic cap.
VBAT	37	I	Provides VBAT information to the on-time circuits for both converters. A 10-kΩ series resistor protects the adjacent pins from inadvertent shorts due to solder bridges or mis-probing during test.
VCLK	18	I	SVID clock. 1-V logic level.
VDIO	20	I/O	SVID digital I/O line. 1-V logic level.
VREF	14	O	1.7-V, 500-μA reference. Bypass to GND with a 0.22-μF ceramic capacitor.

**TPS51640A, TPS59640, TPS59641**

SLUSAQ2 – JANUARY 2012

[www.ti.com](http://www.ti.com)

PIN		I/O	DESCRIPTION
NAME	NO.		
VR_ON	16	I	IMVP-7 VR enable; 1V I/O level; 100-ns de-bounce. Regulator enters controlled soft-stop when brought low.
$\overline{\text{VR\_HOT}}$	21	O	IMVP-7 thermal flag open drain output – active low. Typically pulled up to 1-V logic level through 56 $\Omega$ . Fall time < 100 ns. 1-ms de-glitch using consecutive 1-ms samples.
PAD	GND	–	Thermal pad and analog circuit reference; tie to a quiet area in the system ground plane with multiple vias.

**TYPICAL CHARACTERISTICS**  
**3-Phase Configuration, 94-A CPU**

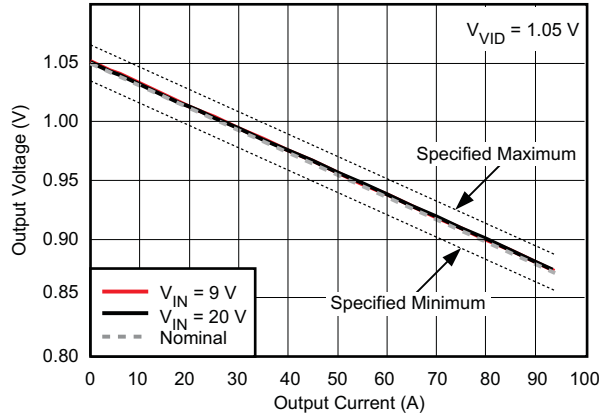

Figure 1. Output Voltage vs. Load Current in PS0

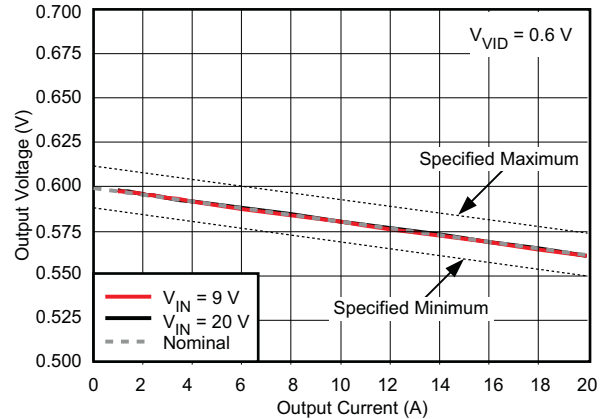

Figure 2. Output Voltage vs. Load Current in PS1

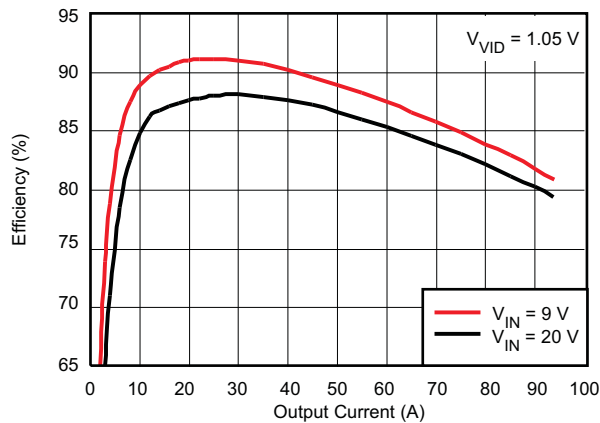

Figure 3. Efficiency vs. Load Current in PS0

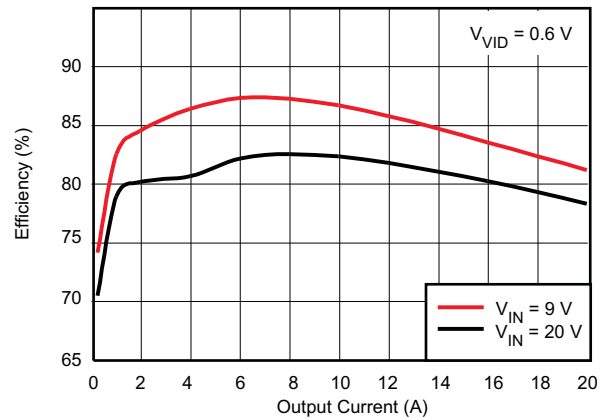

Figure 4. Efficiency vs. Load Current in PS1

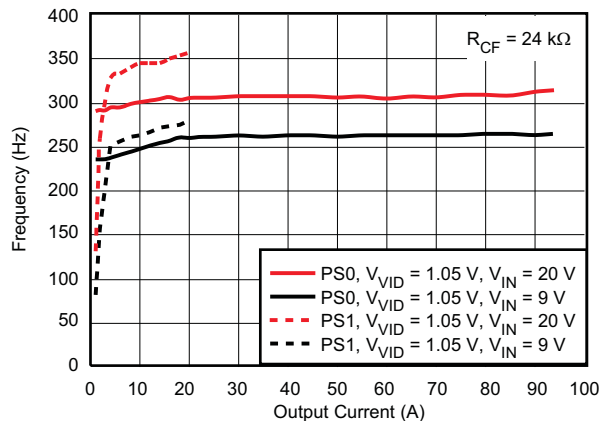

Figure 5. Frequency vs Load-Current (PS0 and PS1)

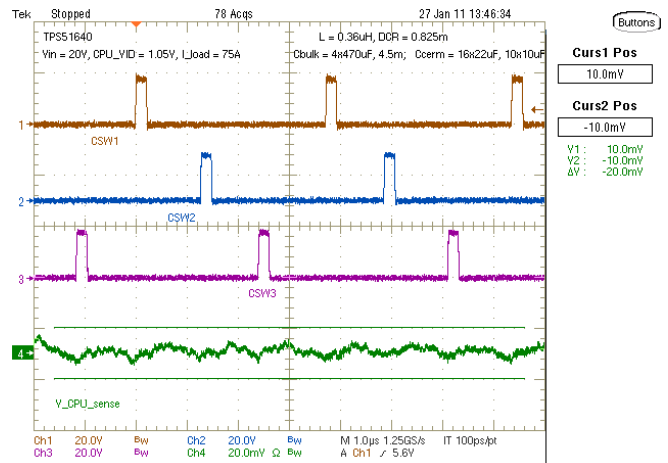
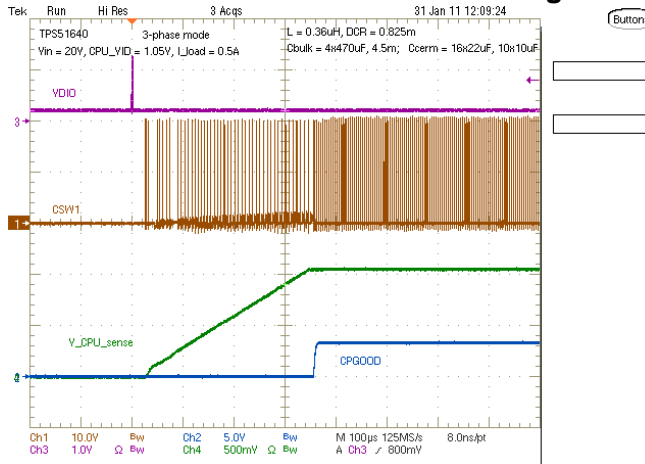

Figure 6. Switching Ripple in PS0, V<sub>IN</sub> = 20 V

## TYPICAL CHARACTERISTICS

### 3-Phase Configuration, 94-A CPU (continued)



**Figure 7. Start-Up and PGOOD (TPS51640A and TPS59640 Only)**

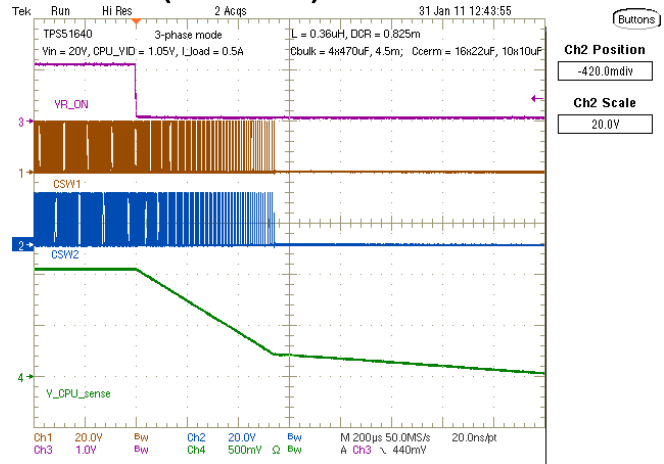

**Figure 8. Soft-Stop**

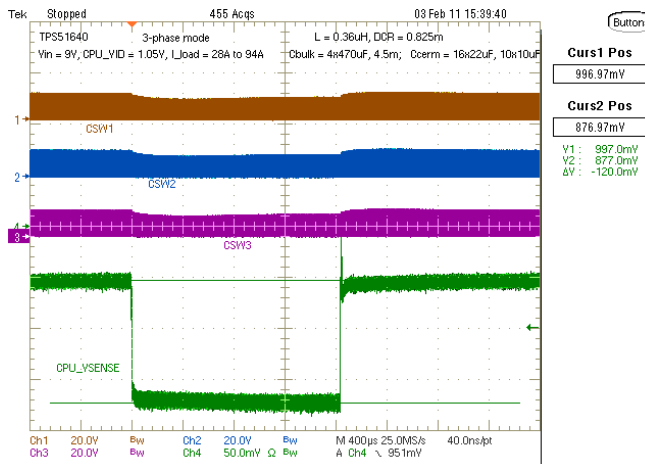

**Figure 9. Load Transient, V<sub>IN</sub> = 9 V, Load step = 66 A**

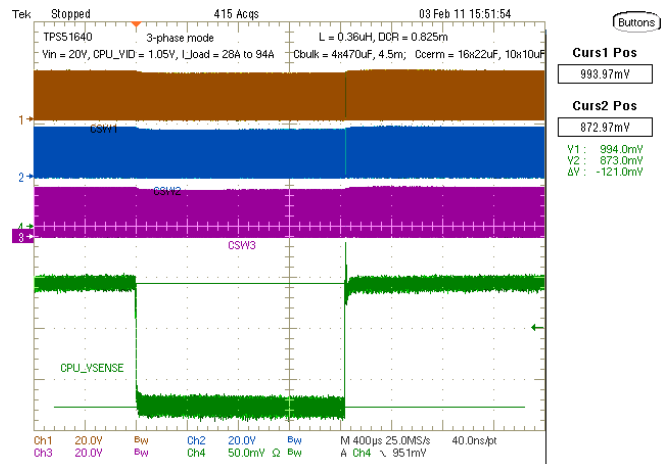

**Figure 10. Load Transient, V<sub>IN</sub> = 20 V, Load step = 66 A**

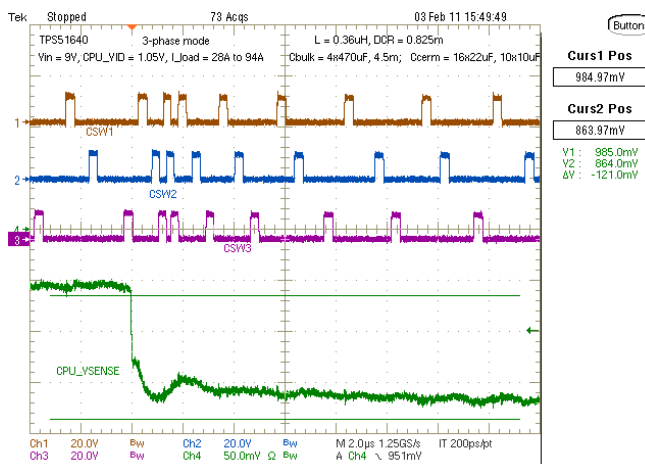

**Figure 11. Load Insertion, V<sub>IN</sub> = 9 V, Load step = 66 A**

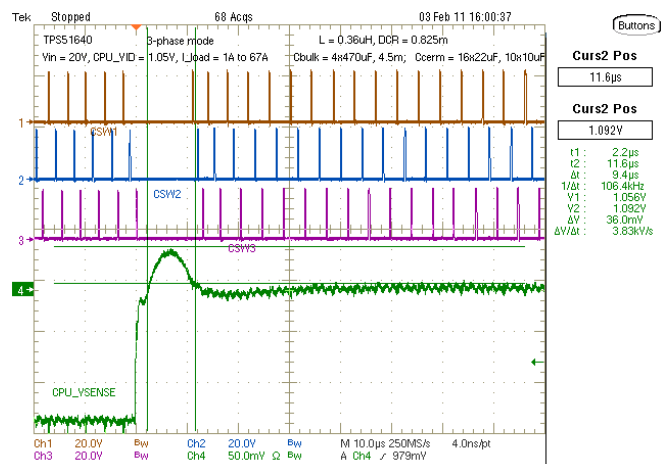

**Figure 12. Load Release, V<sub>IN</sub> = 20 V, Load step = 66 A**

### TYPICAL CHARACTERISTICS 3-Phase Configuration, 94-A CPU (continued)

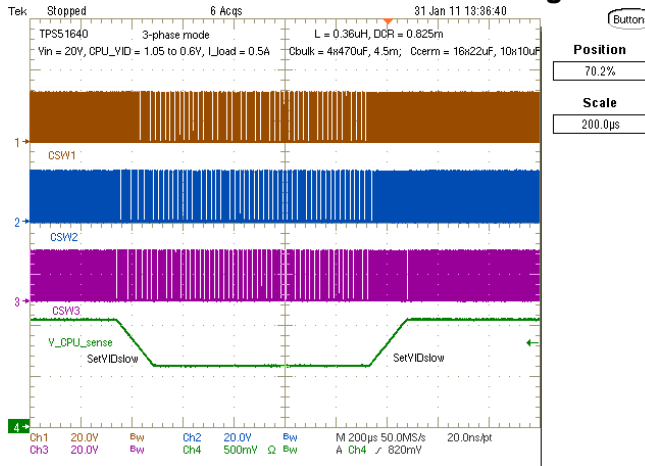

Figure 13. Dynamic VID: SetVID-Slow/SetVID-Slow

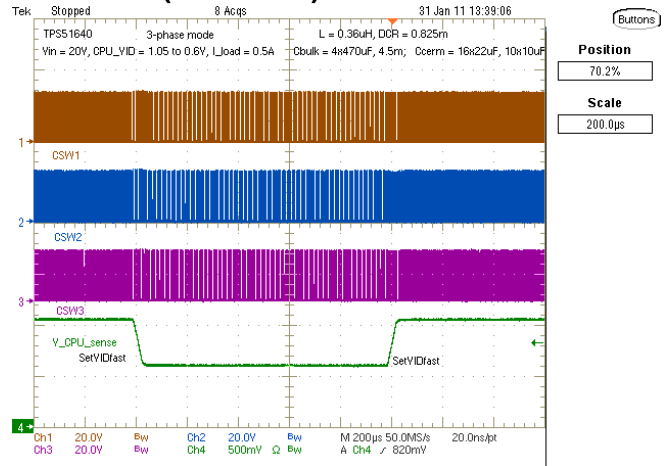

Figure 14. Dynamic VID: SetVID-Fast/SetVID-Fast

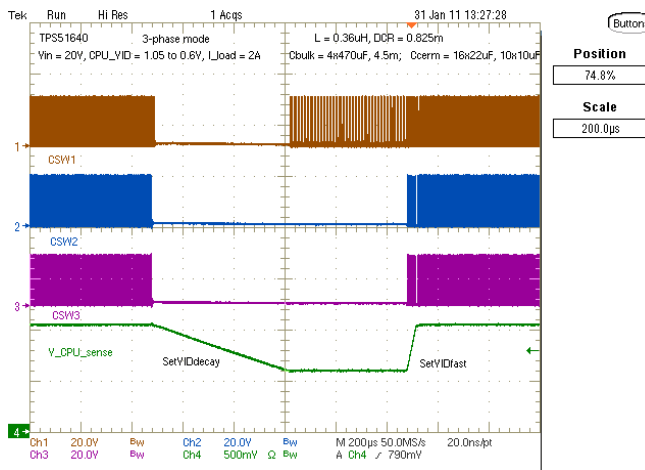

Figure 15. SetVID-Decay/SetVID-Fast

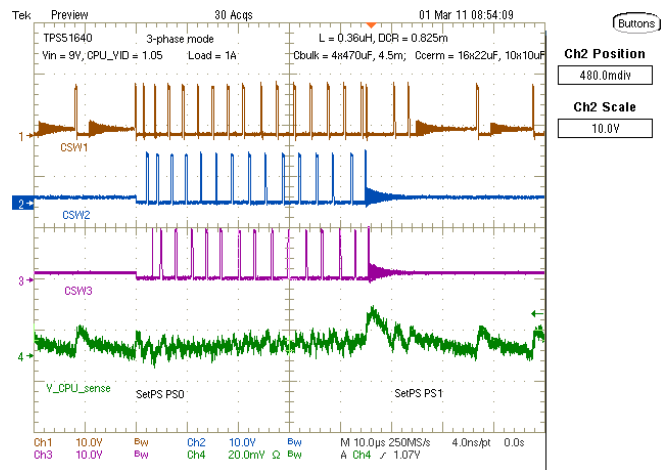

Figure 16. PS Change PS0 to PS1 Toggle

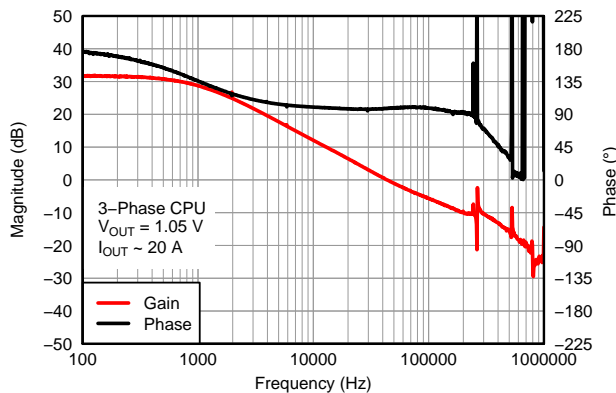

Figure 17. CPU Bode Plot

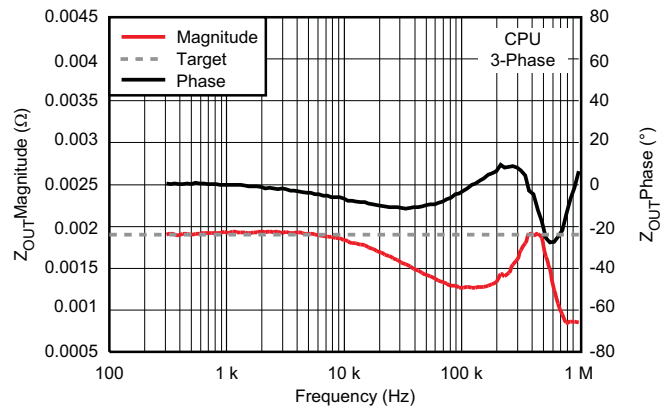

Figure 18. Output Impedance

TYPICAL CHARACTERISTICS  
2-Phase Configuration, 53-A CPU

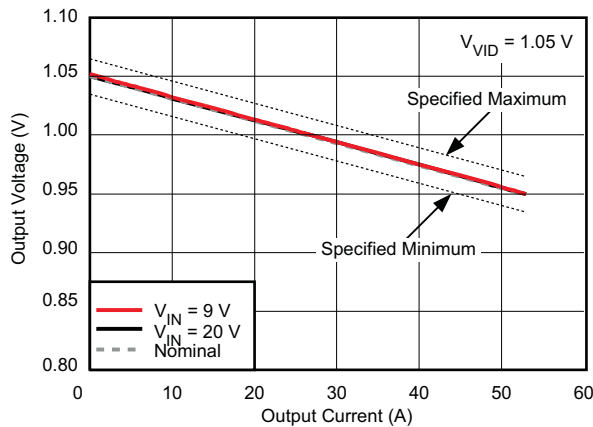

Figure 19. Output Voltage Vs. Load Current in PS0

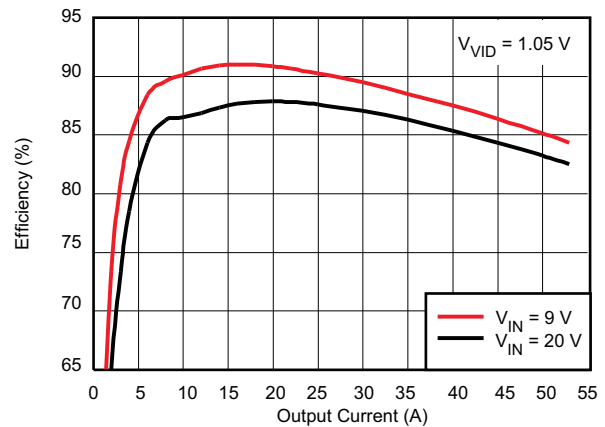

Figure 20. Efficiency Vs. Load Current in PS0

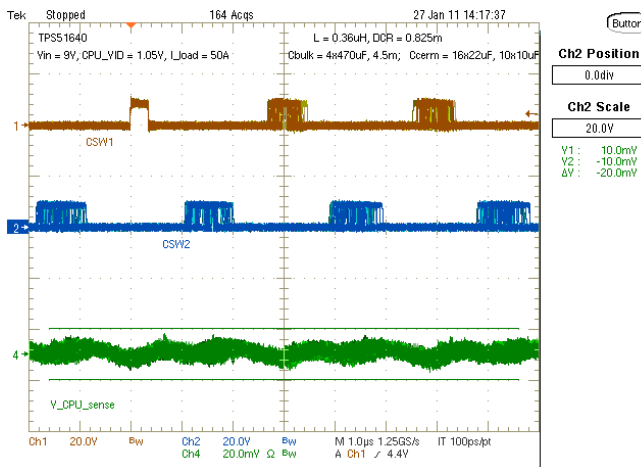

Figure 21. Switching Ripple in PS0 (Persistence),  $V_{IN} = 9\text{ V}$

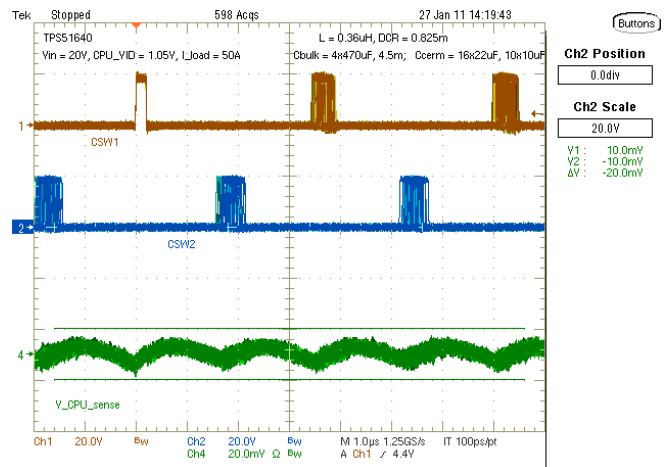

Figure 22. Switching Ripple in PS0 (Persistence),  $V_{IN} = 20\text{ V}$

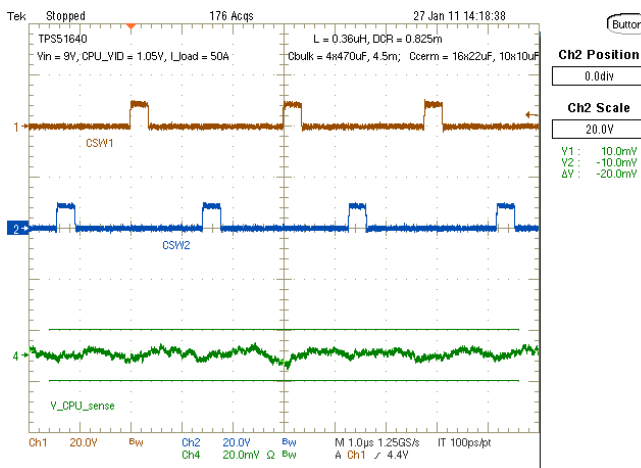

Figure 23. Switching Ripple in PS0,  $V_{IN} = 9\text{ V}$

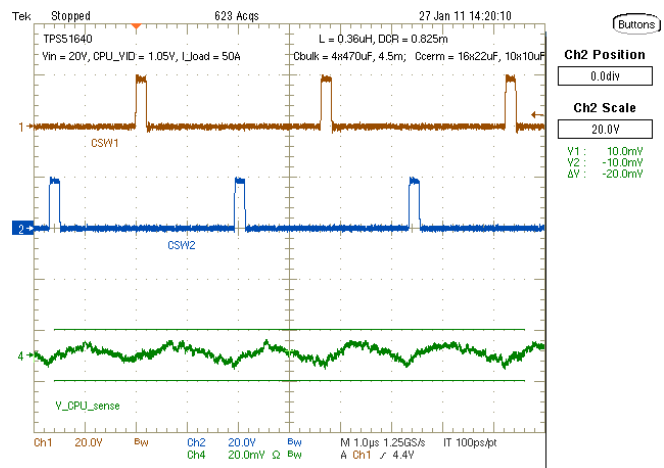

Figure 24. Switching Ripple in PS0,  $V_{IN} = 20\text{ V}$



## TYPICAL CHARACTERISTICS

### 2-Phase Configuration, 53-A CPU (continued)

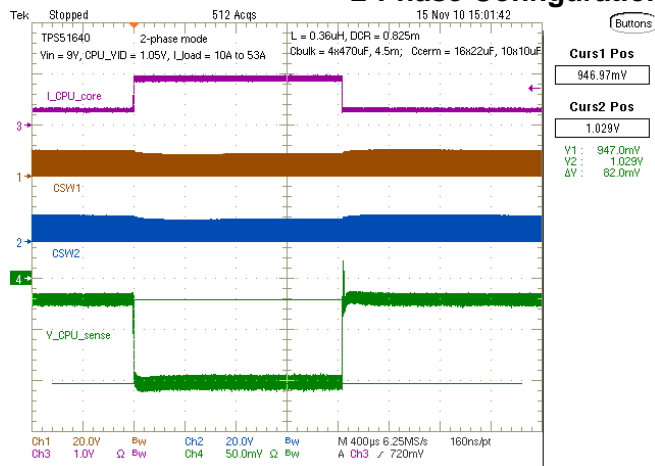

Figure 25. Load Transient, V<sub>IN</sub> = 9 V, Load Step = 43 A

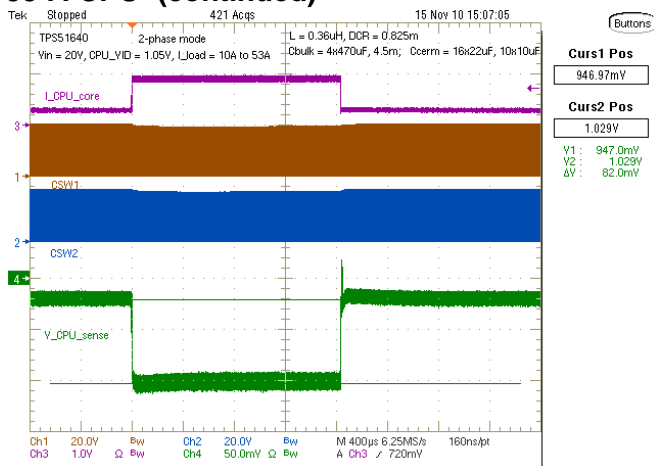

Figure 26. Load Transient, V<sub>IN</sub> = 20 V, Load Step = 43 A

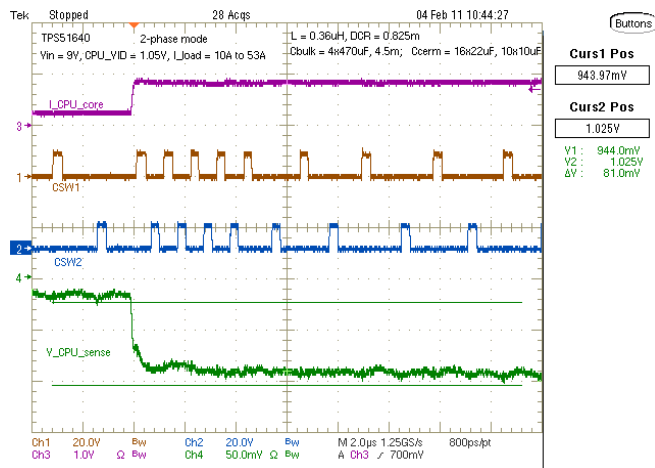

Figure 27. Load Insertion, V<sub>IN</sub> = 9 V, Load Step = 43 A, OSR/USR Setting 150 kΩ

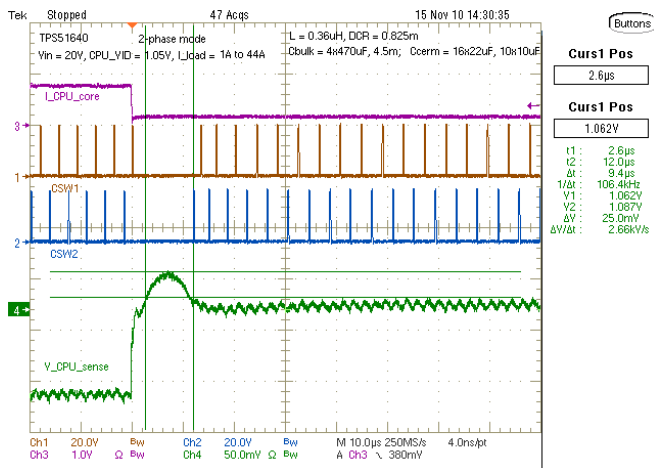

Figure 28. Load Release, V<sub>IN</sub> = 20 V, Load Step = 43 A, OSR/USR Setting 150 kΩ

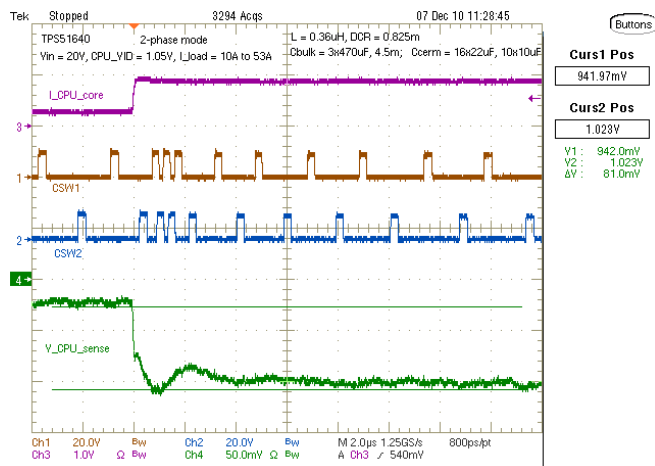

Figure 29. Load Insertion, V<sub>IN</sub> = 9 V, Load Step = 43 A, OSR/USR Setting 39 kΩ (Reduced Output Capacitance)

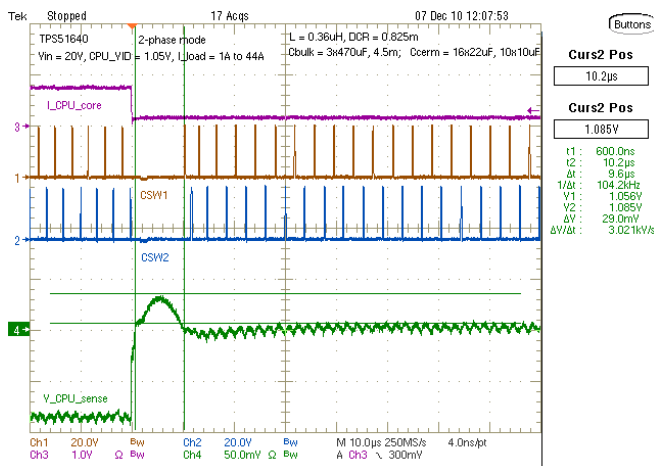

Figure 30. Load Release, V<sub>IN</sub> = 20 V, Load Step = 43 A, OSR/USR Setting 39 kΩ (Reduced Output Capacitance)

TYPICAL CHARACTERISTICS  
2-Phase Configuration, 53-A CPU (continued)

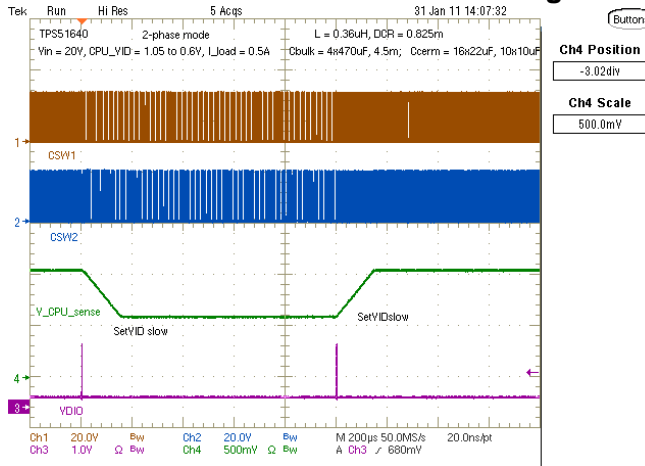

Figure 31. Dynamic VID: SetVID-Slow/SetVID-Slow

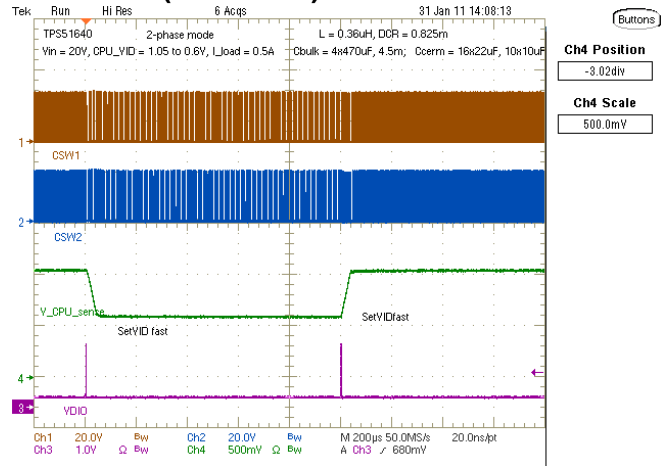

Figure 32. Dynamic VID: SetVID-Fast/SetVID-Fast

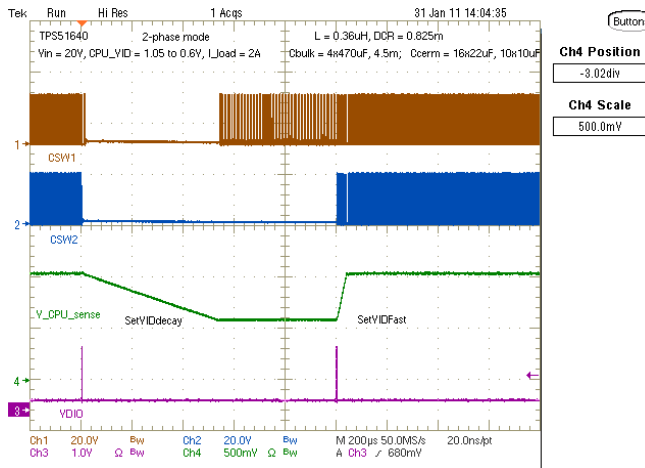

Figure 33. Dynamic VID: SetVID-Decay/SetVID-Fast, I<sub>LOAD</sub> = 2 A

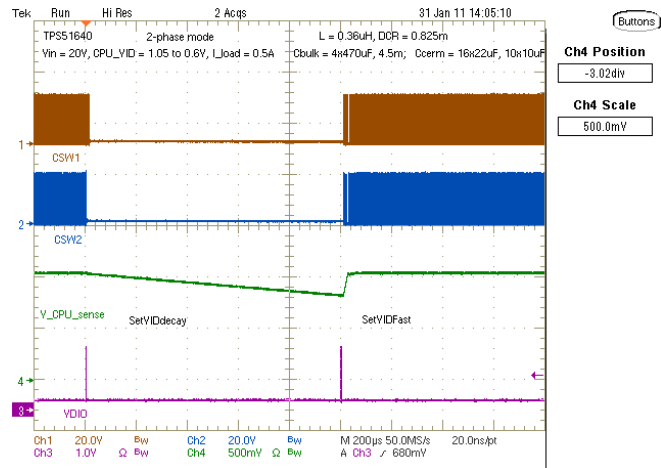

Figure 34. Dynamic VID: SetVID-Decay/SetVID-Fast, I<sub>LOAD</sub> = 0.5 A

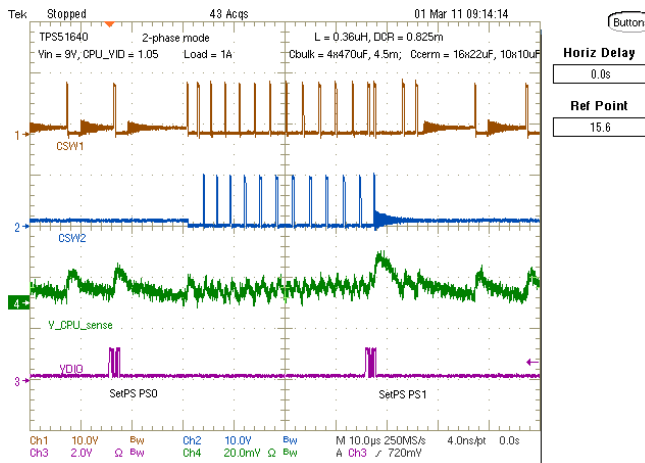

Figure 35. PS Change PS0 to PS1 Toggle

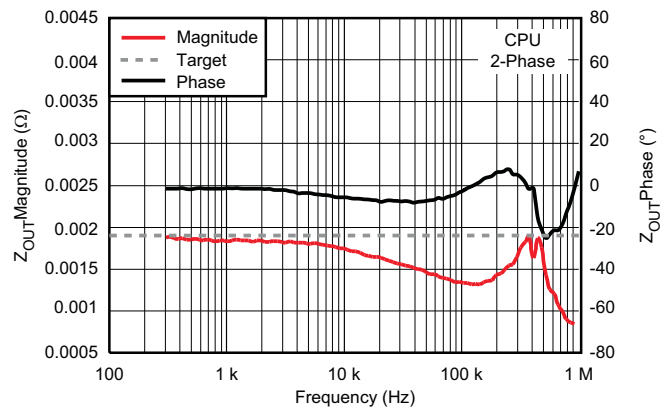

Figure 36. Output Impedance

TYPICAL CHARACTERISTICS  
1-Phase Configuration, 33-A GPU

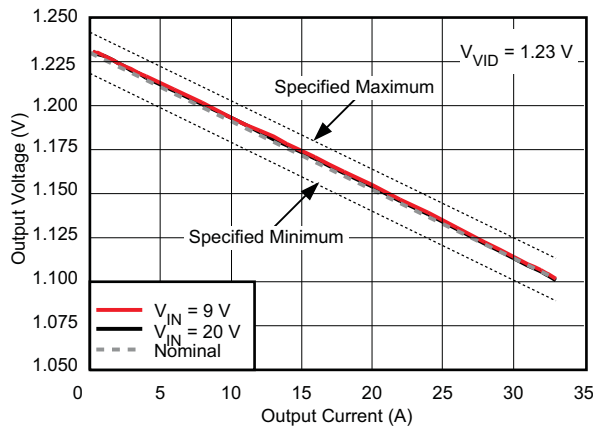

Figure 37. Output Voltage Vs. Load Current in PS0

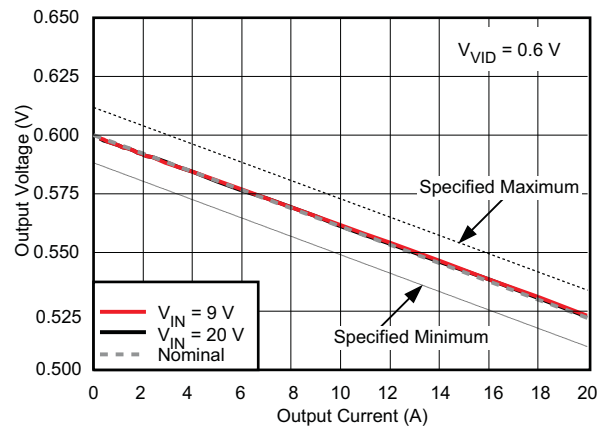

Figure 38. Output Voltage Vs. Load Current in PS1

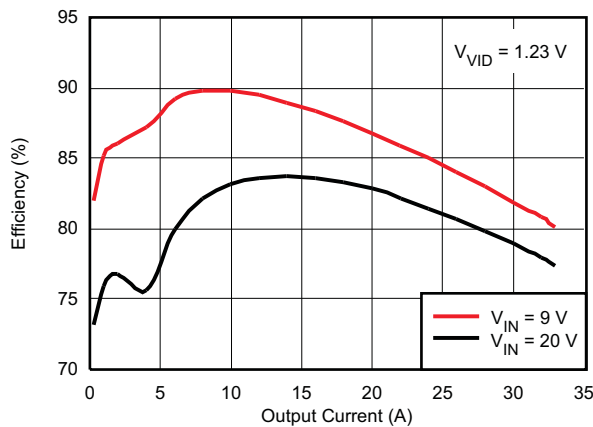

Figure 39. Efficiency Vs. Load Current in PS0

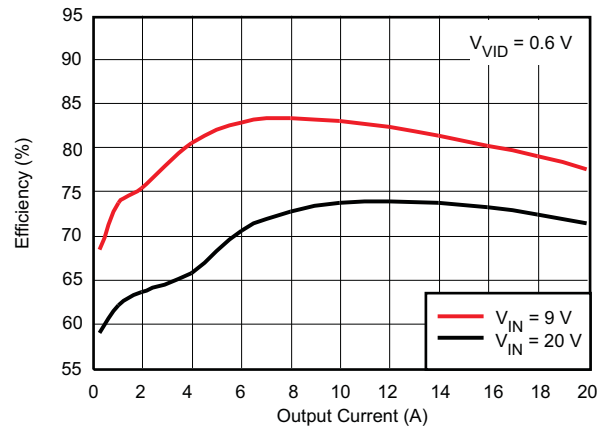

Figure 40. Efficiency Vs. Load Current in PS1

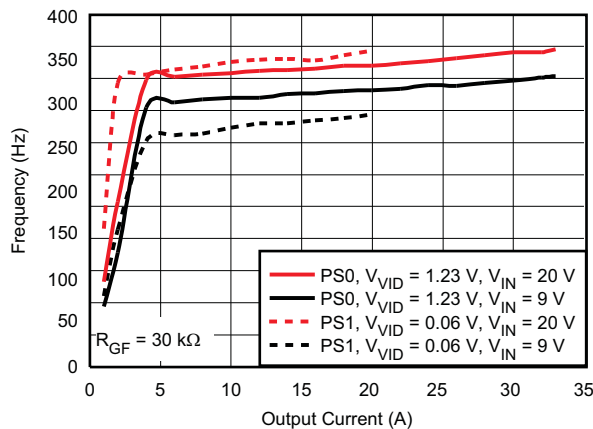

Figure 41. Frequency Vs. Load Current

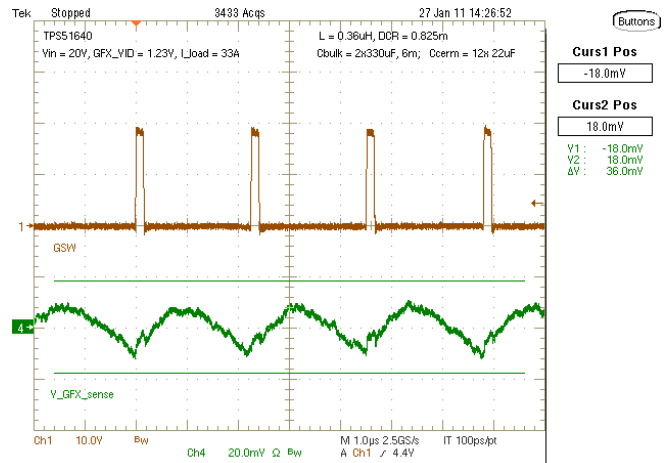

Figure 42. Switching Ripple in PS0

TYPICAL CHARACTERISTICS  
1-Phase Configuration, 33-A GPU (continued)

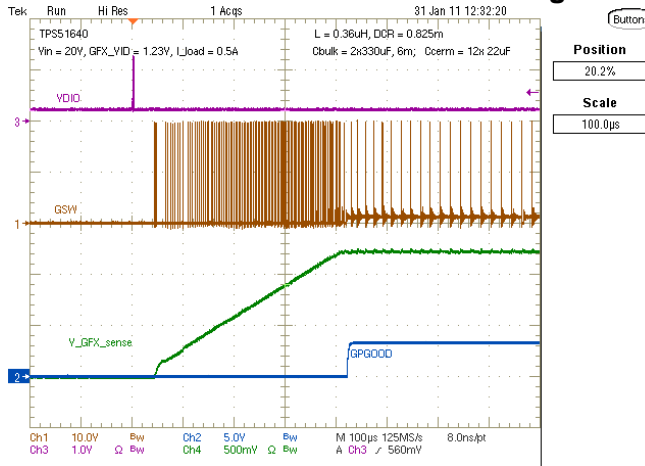

Figure 43. Start-Up and PGOOD (TPS51640A and TPS59640 Only)

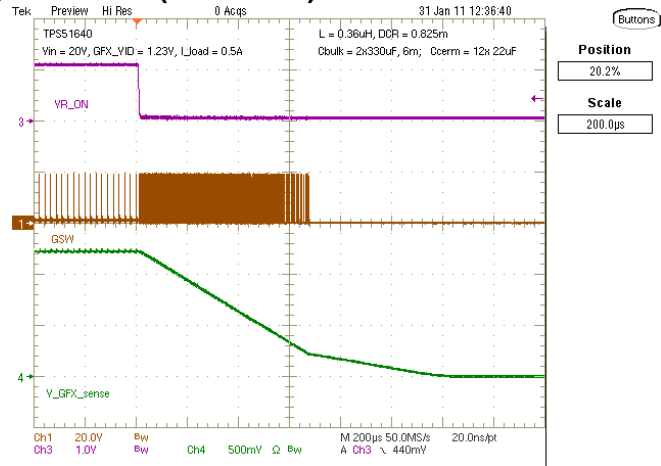

Figure 44. Soft-Stop

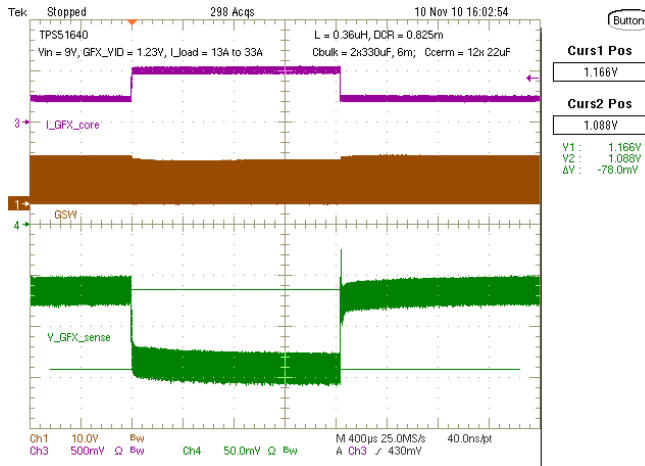

Figure 45. Load Transient,  $V_{IN} = 9\text{ V}$ , Load Step = 20 A

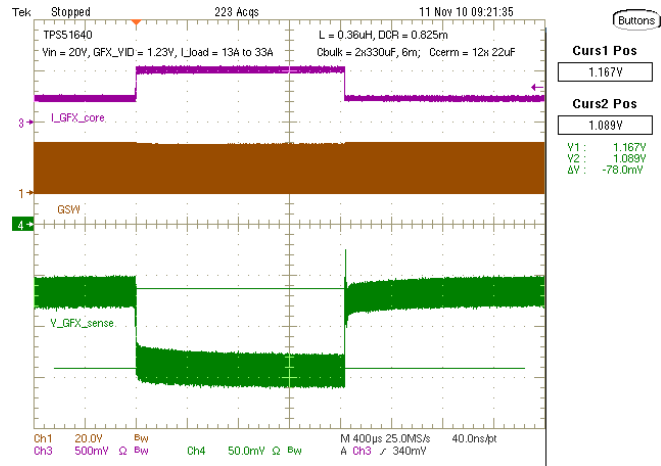

Figure 46. Load Transient,  $V_{IN} = 20\text{ V}$ , Load Step = 20 A

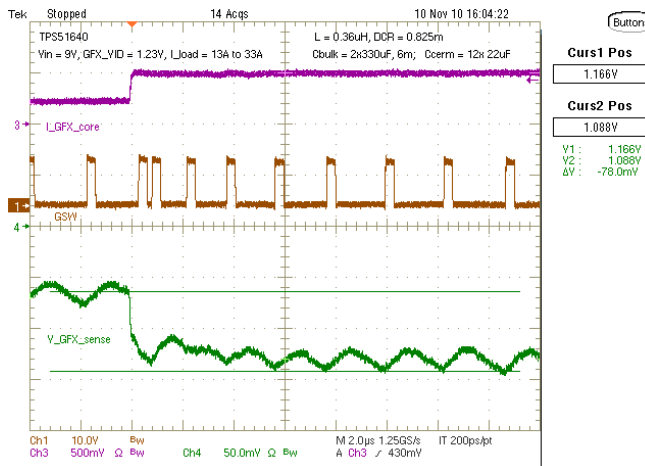

Figure 47. Load Insertion,  $V_{IN} = 9\text{ V}$ , Load Step = 20 A

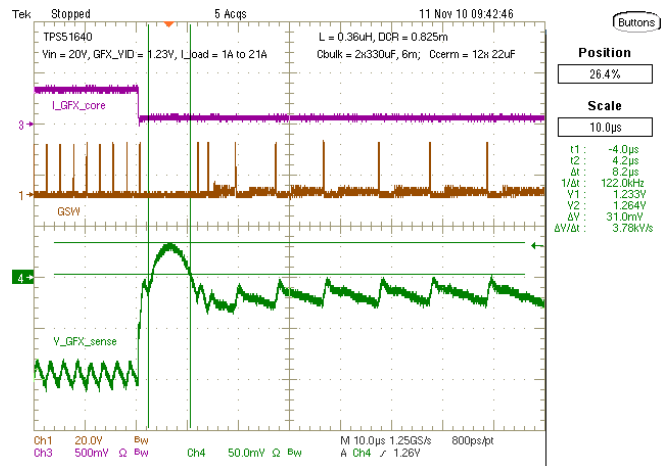

Figure 48. Load Release,  $V_{IN} = 20\text{ V}$ , Load Step = 20 A

### TYPICAL CHARACTERISTICS

#### 1-Phase Configuration, 33-A GPU (continued)

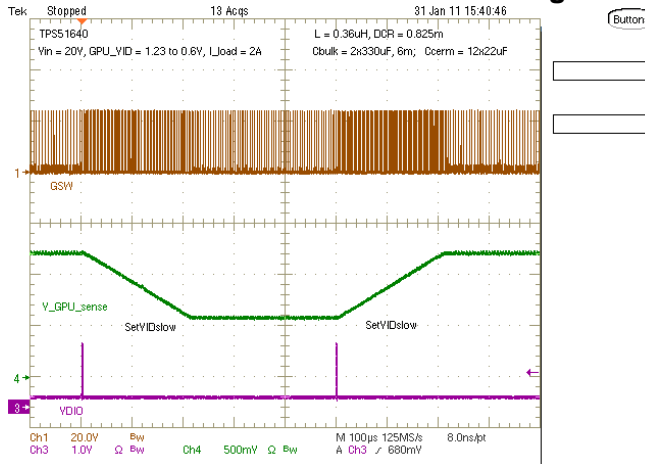

Figure 49. Dynamic VID: SetVID-Slow/SetVID-Slow

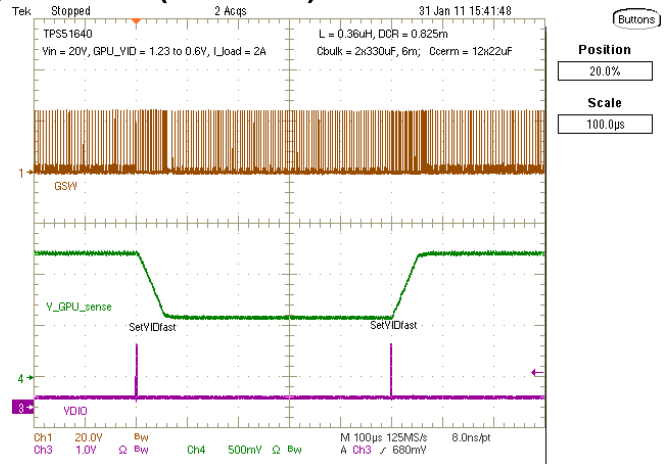

Figure 50. Dynamic VID: SetVID-Fast/SetVID-Fast

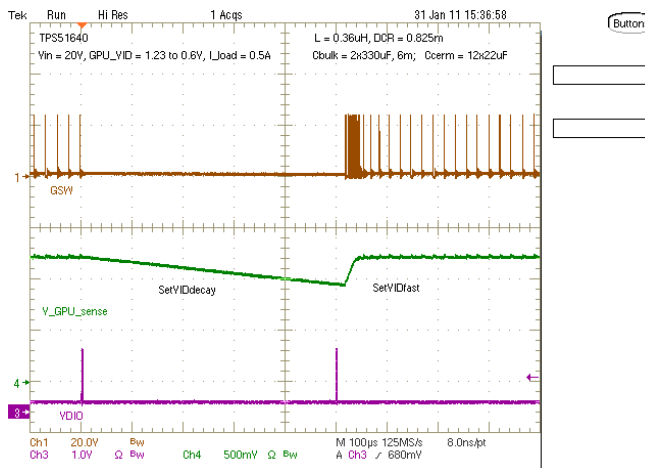

Figure 51. Dynamic VID: SetVID-Decay/SetVID-Fast,  $I_{LOAD} = 0.5 A$

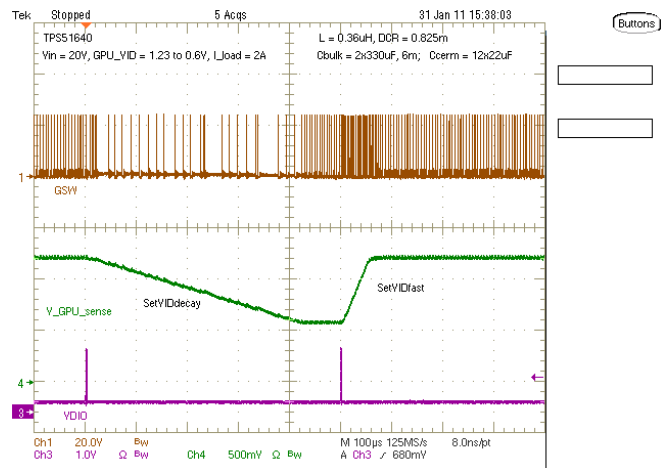

Figure 52. Dynamic VID: SetVID-Decay/SetVID-Fast,  $I_{LOAD} = 2 A$

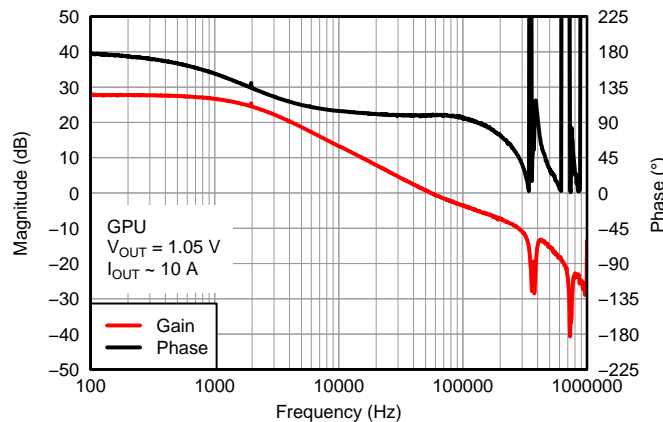

Figure 53. Bode Plot

TYPICAL CHARACTERISTICS (TPS59641 ONLY)

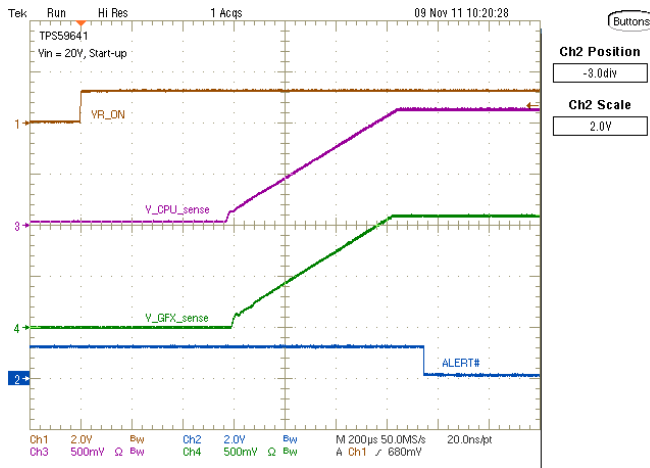

Figure 54. Startup to  $V_{BOOT}$  Voltage and ALERT

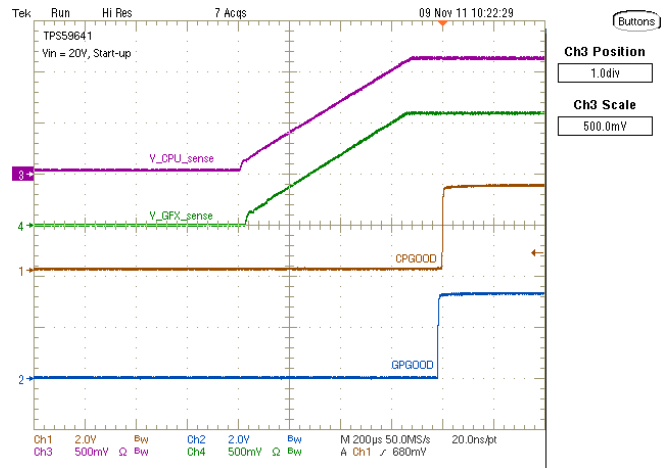
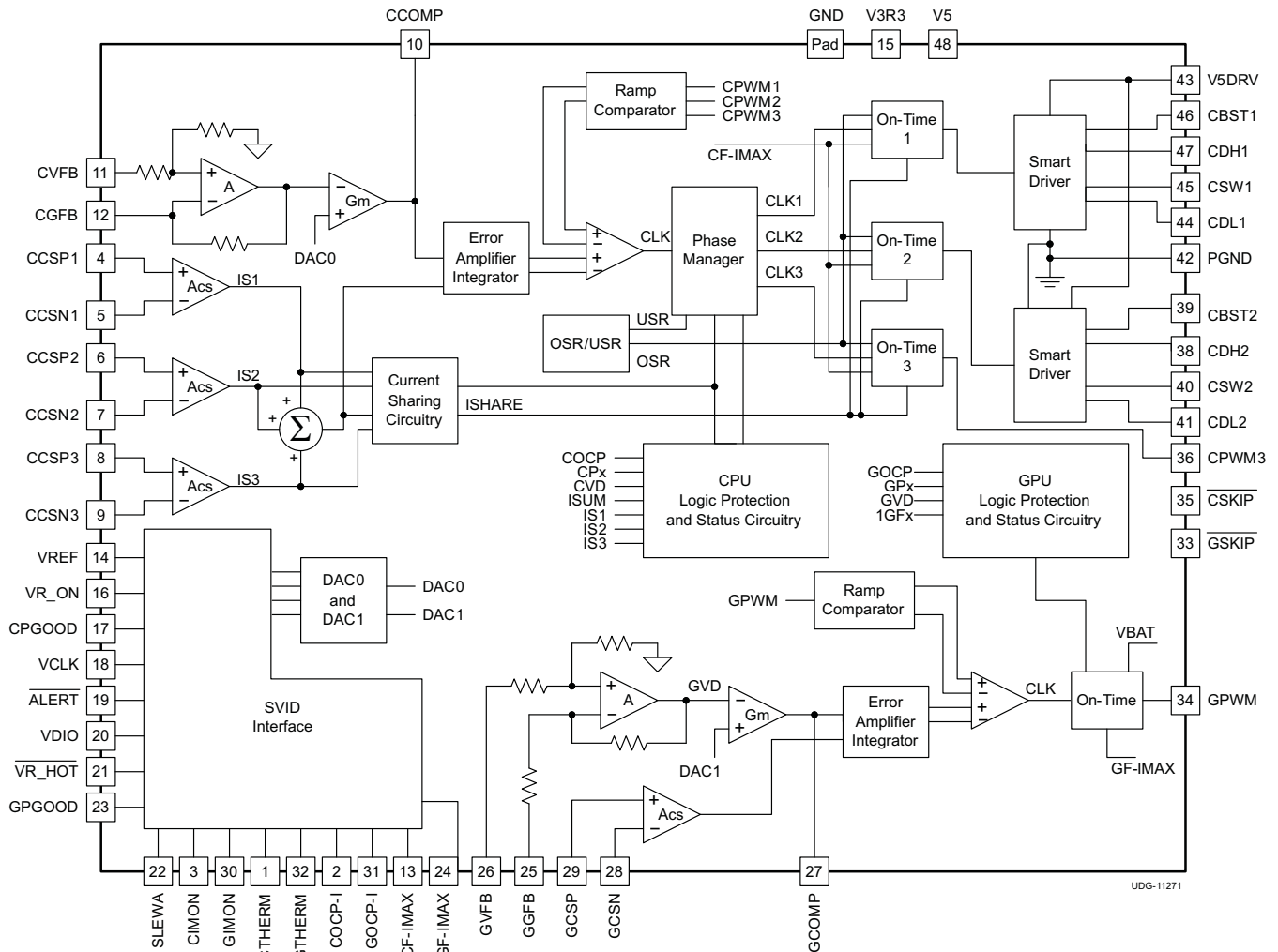

Figure 55. Startup to  $V_{BOOT}$  Voltage and CPGOOD, GPGOOD

FUNCTIONAL BLOCK DIAGRAM



APPLICATION INFORMATION

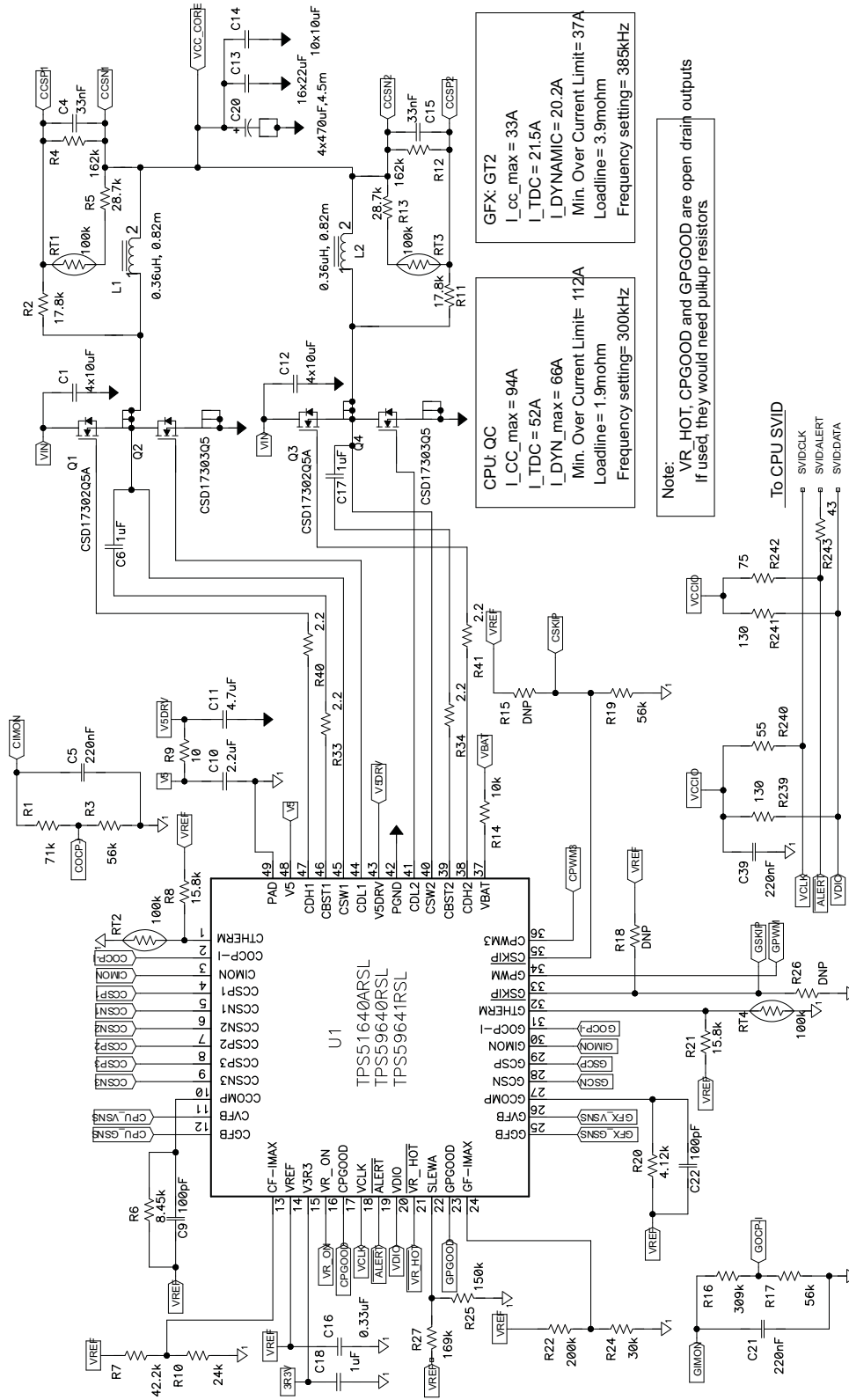
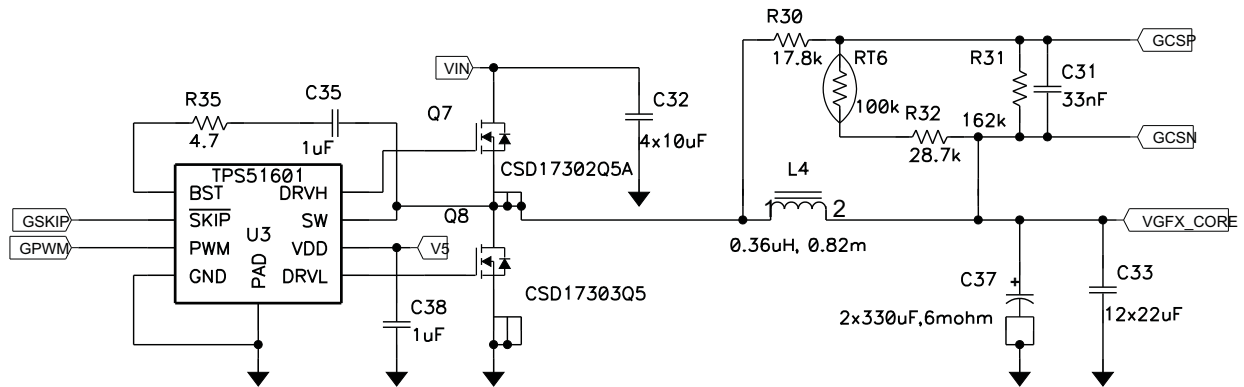

Figure 56. Application for 3-Phase CPU, 1-Phase GPU with Inductor DCR Current Sense (Controller with 2 internal drivers, 1st and 2nd Phase CPU Power)

# TPS51640A, TPS59640, TPS59641

SLUSAQ2 – JANUARY 2012

www.ti.com



**Figure 57. Application for 3-Phase CPU, 1-Phase GPU with Inductor DCR Current Sense continued (External driver, 3rd Phase CPU Power)**

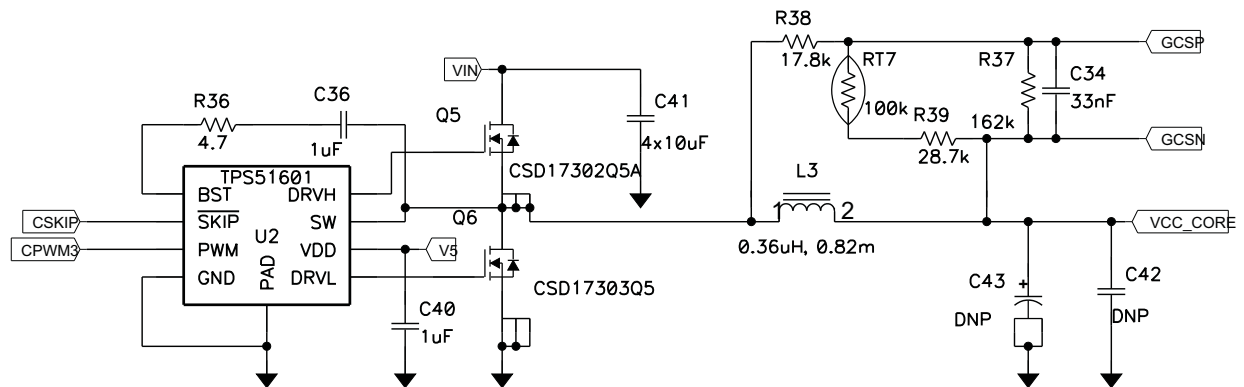

**Figure 58. Application for 3-Phase CPU, 1-Phase GPU with Inductor DCR Current Sense continued (External driver, GPU Power)**



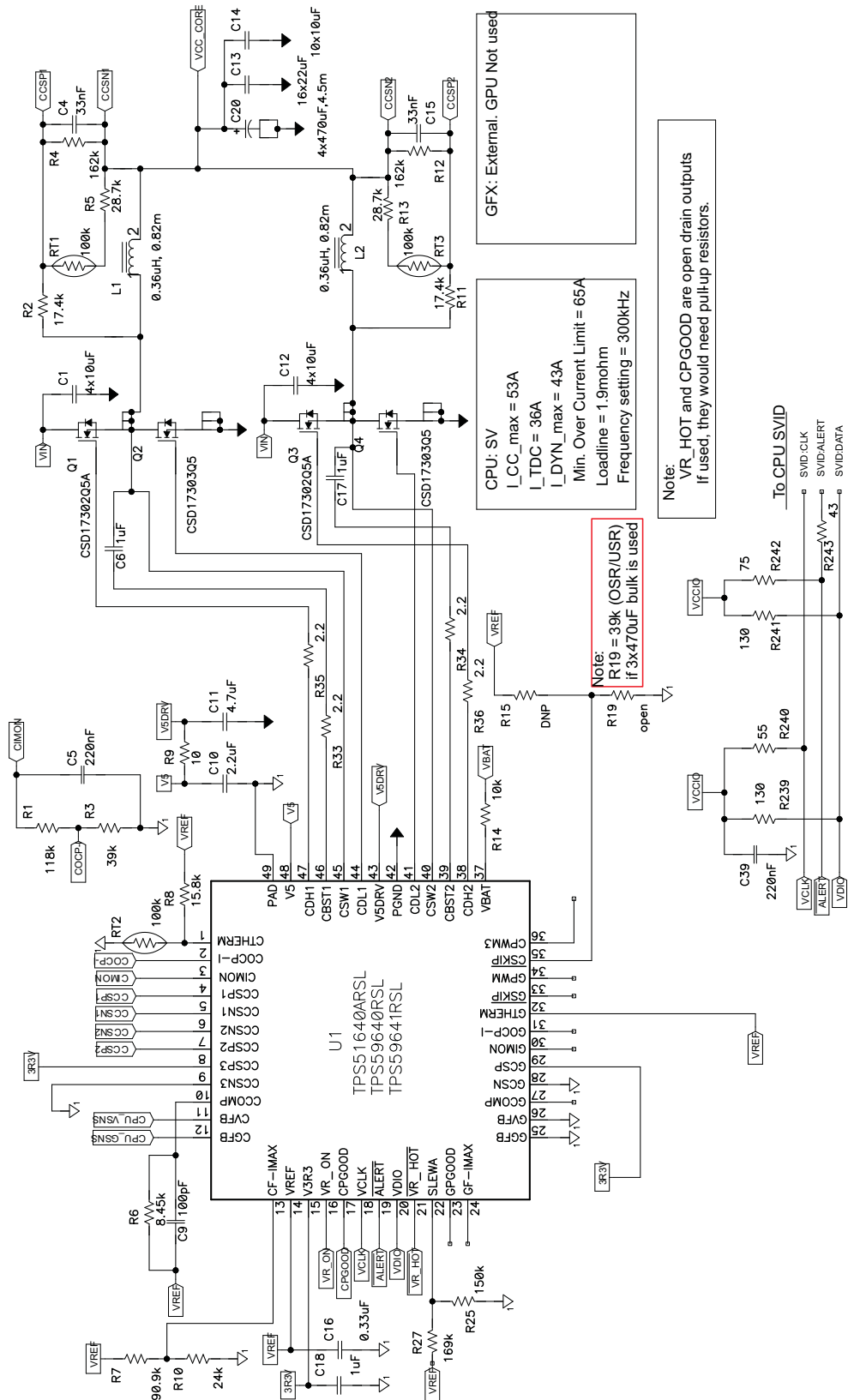

Figure 59. Application for Inductor DCR Current Sense Application Diagram for 2-Phase CPU and GPU Disabled

**Table 1. Key External Component Recommendations**

<b>FUNCTION</b>	<b>MANUFACTURER</b>	<b>COMPONENT NUMBER</b>
High-side MOSFET	Texas Instruments	CSD17302Q5A
Low-side MOSFET	Texas Instruments	CSD17303Q5
Powerblock MOSFET	Texas Instruments	CSD87350Q5D
Inductors	Panasonic	ETQP4LR36AFC
	NEC-Tokin	MPCH1040LR36, MPCG1040LR36
	TOKO	FDUE1040J-H-R36, FCUL1040xxR36
	ALPS	GLMDR3601A
Bulk Output Capacitors	Panasonic	EEFLXOD471R4
	Sanyo	2TPLF470M4E
	KEMET	T528Z477M2R5AT
Ceramic Output Capacitors	Murata	GRM21BR60J106KE19L
	Murata	GRM21BR60J226ME39L
	Panasonic	ECJ2FB0J106K
	Panasonic	ECJ2FB0J226K
NTC Thermistors	Murata	NCP15WF104F03RC, NCP18WF104F03RC
	Panasonic	ERTJ1VS104F, ERTJ0ES104F
Sense Resistors	Vishay	WSK0612L7500FEA
	Stackpole	CSSK0612FTL750

## DETAILED DESCRIPTION

### Functional Overview

The TPS51640A, TPS59640, and TPS59641 are a DCAP+™ mode adaptive on-time controllers.

The output voltage is set using a DAC that outputs a reference in accordance with the 8-bit VID code defined in Intel IMVP-7 PWM Specification document. In adaptive on-time converters, the controller varies the on-time as a function of input and output voltage to maintain a nearly constant frequency during steady-state conditions. In conventional voltage-mode constant on-time converters, each cycle begins when the output voltage crosses to a fixed reference level. However, in these devices, the cycle begins when the current feedback reaches an error voltage level which corresponds to the amplified difference between the DAC voltage and the feedback output voltage. In the case of two-phase or three-phase operation, the current feedback from all the phases is summed up at the output of the internal current-sense amplifiers.

This approach has two advantages:

- The amplifier DC gain sets an accurate linear load-line; this is required for CPU core applications.
- The error voltage input to the PWM comparator is filtered to improve the noise performance.

In addition, the difference of the DAC-to-output voltage and the current feedback goes through an integrator to give a more or less linear load-line even at light loads where the inductor current is in discontinuous conduction mode (DCM).

In a steady-state condition, the phases of the TPS51640A, TPS59640, and TPS59641 switch 180° phase-displacement for two-phase mode and 120° phase-displacement for three-phase mode. The phase displacement is maintained both by the architecture (which does not allow both high-side gate drives to be on in any condition except transients) and the current ripple (which forces the pulses to be spaced equally). The controller forces current sharing adjusting the on-time of each phase. Current balancing requires no user intervention, compensation, or extra components.

## User Selections

After the 5-V and the 3.3-V power are applied to the controller, the controller must be enabled by the VR\_ON signal going high to the VCCIO logic level. At this time, the following information is latched and cannot be changed anytime during operation. The [ELECTRICAL CHARACTERISTICS](#) table defines the values of each of the selections.

- **Operating Frequency.** The resistor from CF-IMAX pin to GND sets the frequency of the CPU channel. The resistor from GF-IMAX to GND sets the frequency of the GPU channel. See the [ELECTRICAL CHARACTERISTICS](#) table for the resistor settings corresponding to each frequency selection. It is to be noted that the operating frequency is a quasi-fixed frequency in the sense that the ON time is fixed based on the input voltage (at the VBAT pin) and output voltage (set by VID). The OFF time varies based on various factors such as load and power-stage components.
- **Maximum Current Limit ( $I_{CC(max)}$ ) Information.** The  $I_{CC(max)}$  information of the CPU, which can be set by the voltage on the CF-IMAX pin. The  $I_{CC(max)}$  information of the GPU channel, which can be set by the voltage on the GF-IMAX pin.
- **Overcurrent Protection (OCP) Level.** The resistor from COCP-I to GND sets the OCP level of the CPU channel. The resistor from GOCP-I to GND sets the OCP level of the GPU channel.
- **Current Monitor (IMON) Gain and Voltage.** The resistor from CIMON to COCP-I sets the CIMON gain and the CIMON voltage for the CPU channel. The resistor from GIMON to GOCP-I sets the GIMON gain and the GIMON voltage for the GPU channel.
- **Overshoot Reduction (OSR) and Undershoot Reduction (USR) Levels.** The resistor from the  $\overline{CSKIP}$  pin to GND sets the OSR and USR for the CPU channel. The resistor from the  $\overline{GSKIP}$  pin to GND sets the OSR and USR level for GPU channel. The OSR can be disabled for CPU and/or GPU by setting a voltage of approximately 200 mV on the corresponding xSKIP pin. This is accomplished by connecting a resistor from VREF to the xSKIP pin.
- **Slew Rate.** The *SetVID-Fast* slew rate is set by the voltage on the SLEWA pin. The rate is the same for both the CPU and GPU channels. The *SetVID-Slow* is  $\frac{1}{4}$  of the *SetVID-Fast* rate.

**Table 2. Key Selections Summary<sup>(1)</sup>**

SELECTION RESISTANCE (k $\Omega$ )	FREQUENCY	OCP	OSR / USR
20	Lowest	Lowest	Least overshoot, least undershoot
24	Rising	Rising	Rising
30			
39			
56			
75			
100	Highest	Highest	Maximum overshoot, maximum undershoot
150			

(1) See [ELECTRICAL CHARACTERISTICS](#) table for complete settings and values.

**Table 3. Active Channels and Phases**

		CCSP1	CCSN1	CCSP2	CCSN2	CCSP3	CCSN3	GCSP	CGSN
<b>CPU (Active Phases)</b>	<b>3</b>	CS	CS	CS	CS	CS	CS	n/a	n/a
	<b>2</b>	CS	CS	CS	CS	3.3 V	GND	n/a	n/a
	<b>1</b>	CS	CS	3.3 V	GND	GND	GND	n/a	n/a
	<b>OFF</b>	3.3 V	GND	GND	GND	GND	GND	n/a	n/a
<b>GPU (Active Phases)</b>	<b>1</b>	n/a	n/a	n/a	n/a	n/a	n/a	CS	CS
	<b>OFF</b>	n/a	n/a	n/a	n/a	n/a	n/a	3.3 V	GND

## PWM Operation

Referring to the [FUNCTIONAL BLOCK DIAGRAM](#) and [Figure 60](#), in continuous conduction mode, the converter operates as shown in [Figure 60](#).

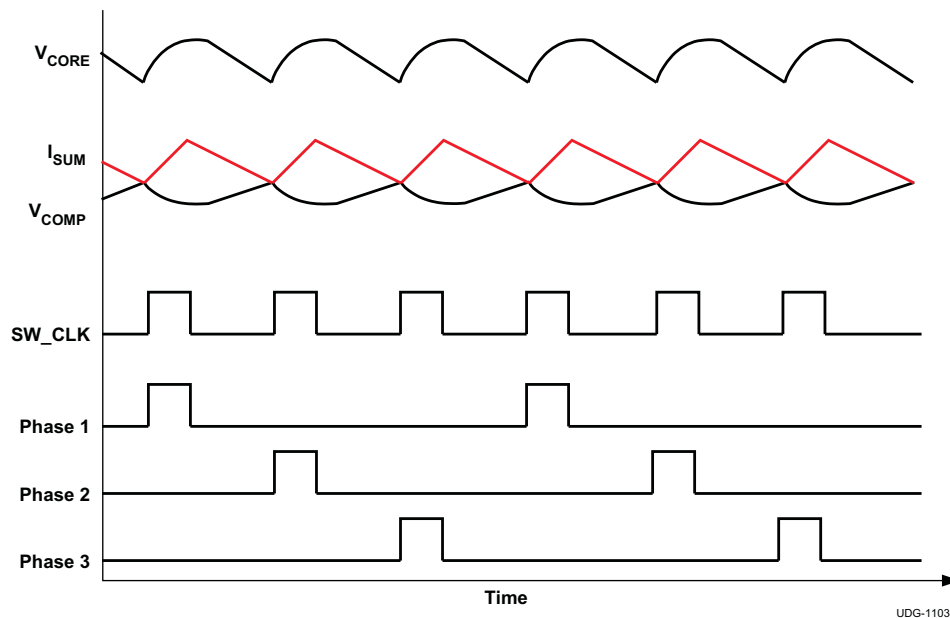

**Figure 60. D-CAP+ Mode Basic Waveforms**

Starting with the condition that the high-side FETs are off and the low-side FETs are on, the summed current feedback ( $I_{SUM}$ ) is higher than the error amplifier output ( $V_{COMP}$ ).  $I_{SUM}$  falls until it reaches the  $V_{COMP}$  level, which contains a component of the output ripple voltage. The PWM comparator senses where the two waveform values cross and triggers the on-time generator. This generates the internal SW\_CLK. Each SW\_CLK corresponds to one switching ON pulse for one phase.

During single-phase operation, every SW\_CLK generates a switching pulse on the same phase. Also,  $I_{SUM}$  voltage corresponds to just a single-phase inductor current.

During multi-phase operation, the SW\_CLK is distributed to each of the phases in a cycle. Using the summed inductor current and then cyclically distributing the ON-pulses to each phase automatically yields the required interleaving of  $360/N$ , where  $N$  is the number of phases.

## Current Sensing

The TPS51640A, TPS59640 and TPS59641 provide independent channels of current feedback for every phase. This increases the system accuracy and reduces the dependence of circuit performance on layout compared to an externally summed architecture. The current sensing topology can be *Inductor DCR Sensing*, which yields the best efficiency, or *Resistor Current Sensing*, which provides the most accuracy across wide temperature range. DCR sensing can be optimized by using a NTC thermistor to reduce the variation of current sense with temperature.

The pins CCSP1, CCSN1, CCSP2, CCSN2 and CCSP3, CCSN3 are used for the three phases of the CPU channel. The pins GCSP and GCSN are used for the single-phase GPU channel.

## Setting the Load-line (DROOP)

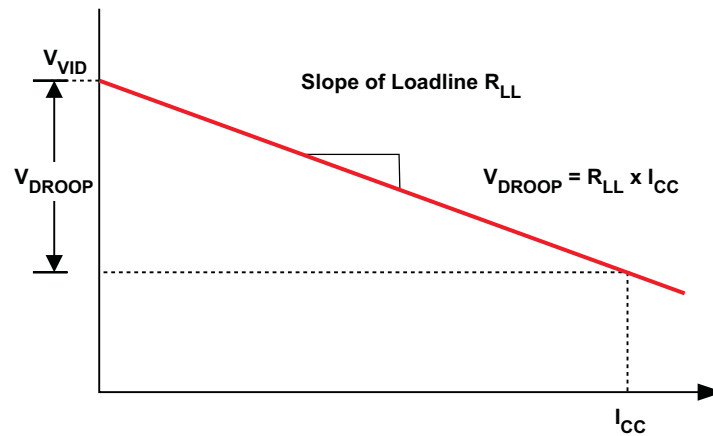

UDG-11032

Figure 61. Load Line

$$V_{\text{DROOP}} = R_{\text{LL}} \times I_{\text{CC}} = \frac{R_{\text{CS(eff)}} \times A_{\text{CS}} \times I_{\text{CC}}}{R_{\text{DROOP}} \times G_{\text{M}}}$$

where

- $A_{\text{CS}}$  is the gain of the current sense amplifier
- $R_{\text{CS(eff)}}$  is the effective current sense resistance, whether a sense resistor or inductor DCR is used
- $I_{\text{CC}}$  is the load current
- $R_{\text{DROOP}}$  is the value of resistor from the DROOP pin to VREF
- $G_{\text{M}}$  is the gain of the droop amplifier

(1)

## Load Transients

When there is a sudden load increase, the output voltage immediately drops. This is reflected as a rising voltage on the COMP pin. This forces the PWM pulses to come in sooner and more frequent which causes the inductor current to rapidly increase. As the inductor current reaches the new load current, a steady-state operating condition is reached and the PWM switching resumes the steady-state frequency.

When there is a sudden load release, the output voltage rises. This is reflected as a falling voltage on the COMP pin. This delays the PWM pulses until the inductor current reaches the new load current level. At that point, switching resumes and steady-state switching continues.

For simplicity, neither [Figure 62](#), nor [Figure 63](#) show the ripple on the Output  $V_{\text{CORE}}$  nor the COMP waveform.

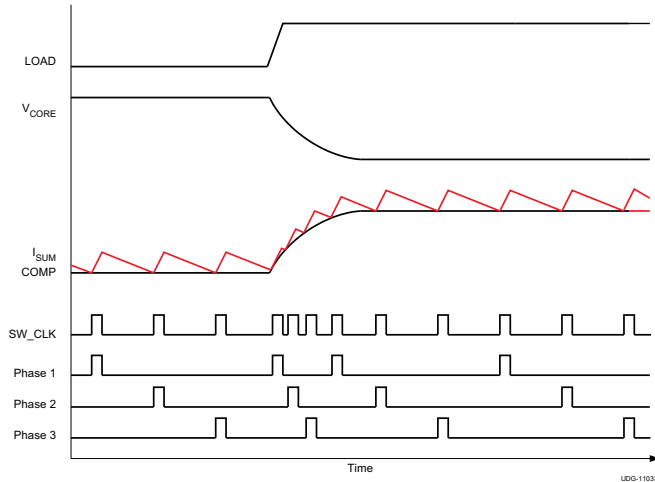

Figure 62. Operating Waveforms During Load Transient

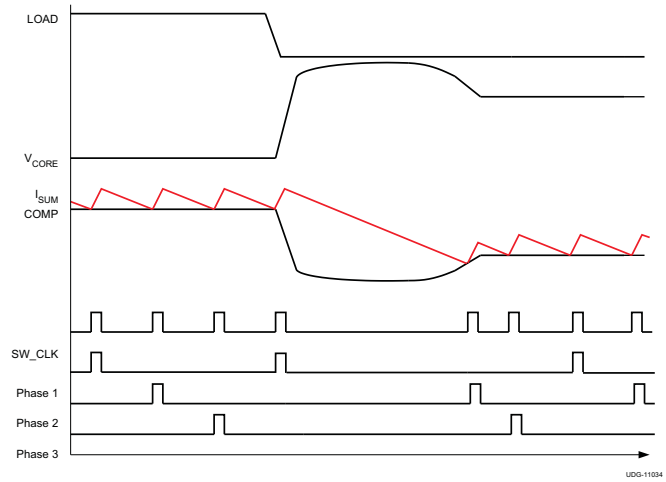

Figure 63. needs a title

### Overshoot Reduction (OSR)

In low duty-cycle synchronous buck converters, an overshoot condition results from the output inductor having a too little voltage ( $V_{CORE}$ ) with which to respond to a transient load release.

In [Figure 64](#), a single phase converter is shown for simplicity. In an ideal converter, with typical input voltage of 12 V and 1.2-V output, the inductor has 10.8 V (12 V – 1.2 V) to respond to a transient load increase, but only 1.2 V with which to respond once the load releases.

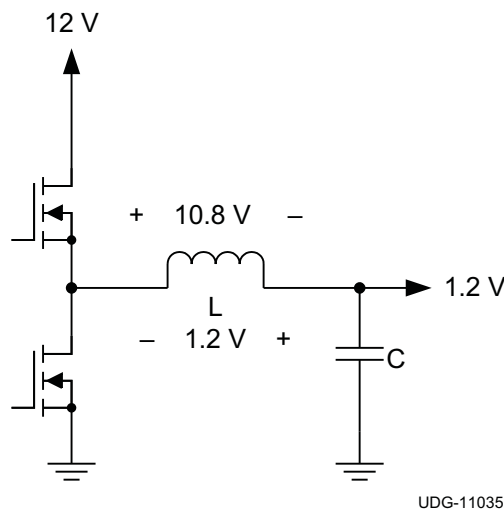

Figure 64. Synchronous Converter

When the overshoot reduction feature is enabled, the output voltage increases beyond a value that corresponds to a voltage difference between the ISUM voltage and the COMP voltage, exceeding the specified OSR voltage specified in the [ELECTRICAL CHARACTERISTICS](#). At that instant, the low-side drivers are turned OFF. When the low-side driver is turned OFF, the energy in the inductor is partially dissipated by the body diodes. As the overshoot reduces, the low-side drivers are turned ON again.

[Figure 65](#) shows the overshoot without OSR. [Figure 66](#) shows the overshoot with OSR. The overshoot reduces by approximately 23 mV. This shows that reduced output capacitance can be used while continuing to meet the specification. Note the low-side driver turning OFF briefly during the overshoot.

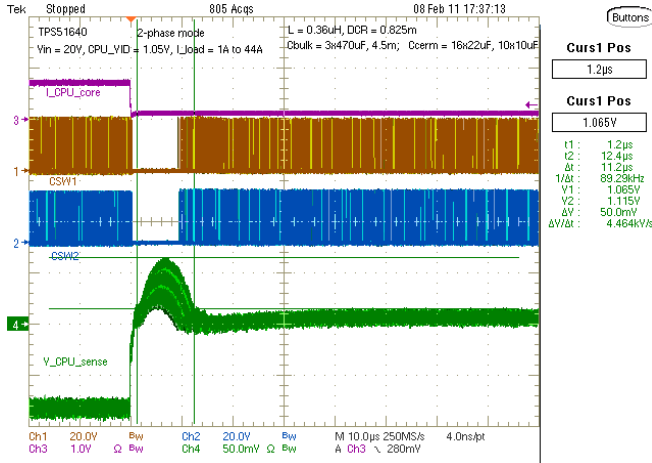

Figure 65. 43-A Load Transient Release Without OSR Enabled.

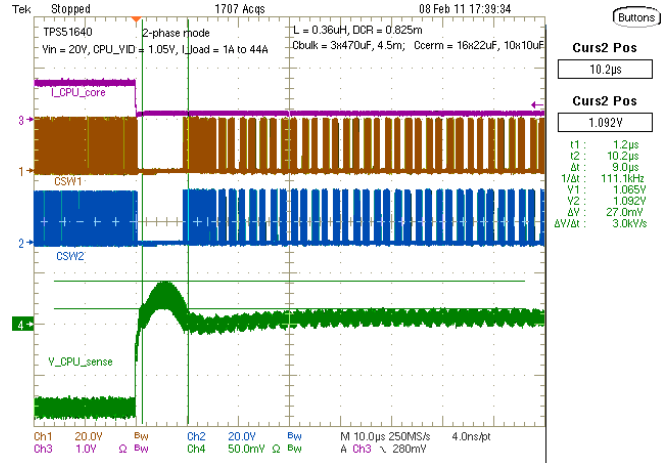

Figure 66. 43-A Load Transient Release With OSR Enabled

### Undershoot Reduction (USR)

When the transient load increase becomes quite large, it becomes difficult to meet the energy demanded by the load especially at lower input voltages. Then it is necessary to quickly increase the energy in the inductors during the transient load increase. This is achieved in these devices by enabling pulse overlapping. In order to maintain the interleaving of the multi-phase configuration and yet be able to have pulse-overlapping during load-insertion, the undershoot reduction (USR) mode is entered only when necessary. This mode is entered when the difference between COMP voltage and ISUM voltage exceeds the USR voltage level specified in the [ELECTRICAL CHARACTERISTICS](#) table.

Figure 67 shows the performance with undershoot reduction. Figure 68 shows the performance without undershoot reduction and that it is possible to eliminate undershoot by enabling the undershoot reduction. This allows reduced output capacitance to be used and still meet the specification.

When the transient condition is over, the interleaving of the phases is resumed. For Figure 67, note the overlapping pulses for Phase 1 and Phase 2 with USR enabled.

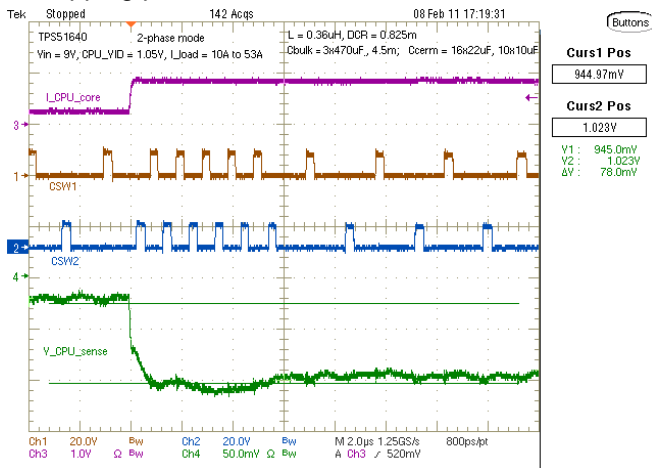

Figure 67. Performance for a 43-A Load Transient Release Without USR Enabled

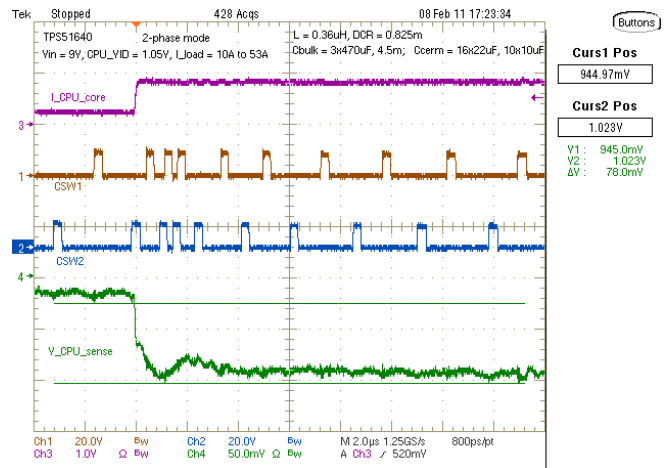

Figure 68. Performance for a 43-A Load Transient Release With USR Enabled

A single-phase GPU operates in a similar way, but instead of pulse-overlap in multi-phase CPU, there is pulse stretching to provide the needs of the transient load increase when USR is enabled.

## AutoBalance™ Current Sharing

The basic mechanism for current sharing is to sense the average phase current, then adjust the pulse width of each phase to equalize the current in each phase. (See [Figure 69](#).)

The PWM comparator (not shown) starts a pulse when the feedback voltage meets the reference. The VBAT voltage charges  $C_{T(ON)}$  through  $R_{T(ON)}$ . The pulse is terminated when the voltage at  $C_{T(ON)}$  matches the  $t_{(ON)}$  reference, normally the DAC voltage ( $V_{DAC}$ ).

The circuit operates in the following fashion, using [Figure 69](#) as the block diagram. First assume that the 5- $\mu$ s averaged value of  $I_1 = I_2 = I_3$ . In this case, the PWM modulator terminates at  $V_{DAC}$ , and the normal pulse width is delivered to the system. If instead,  $I_1 > I_{AVG}$ , then an offset is subtracted from  $V_{DAC}$ , and the pulse width for Phase 1 is shortened, reducing the current in Phase 1 to compensate. If  $I_1 < I_{AVG}$ , then a longer pulse is produced, again compensating on a pulse-by-pulse basis.

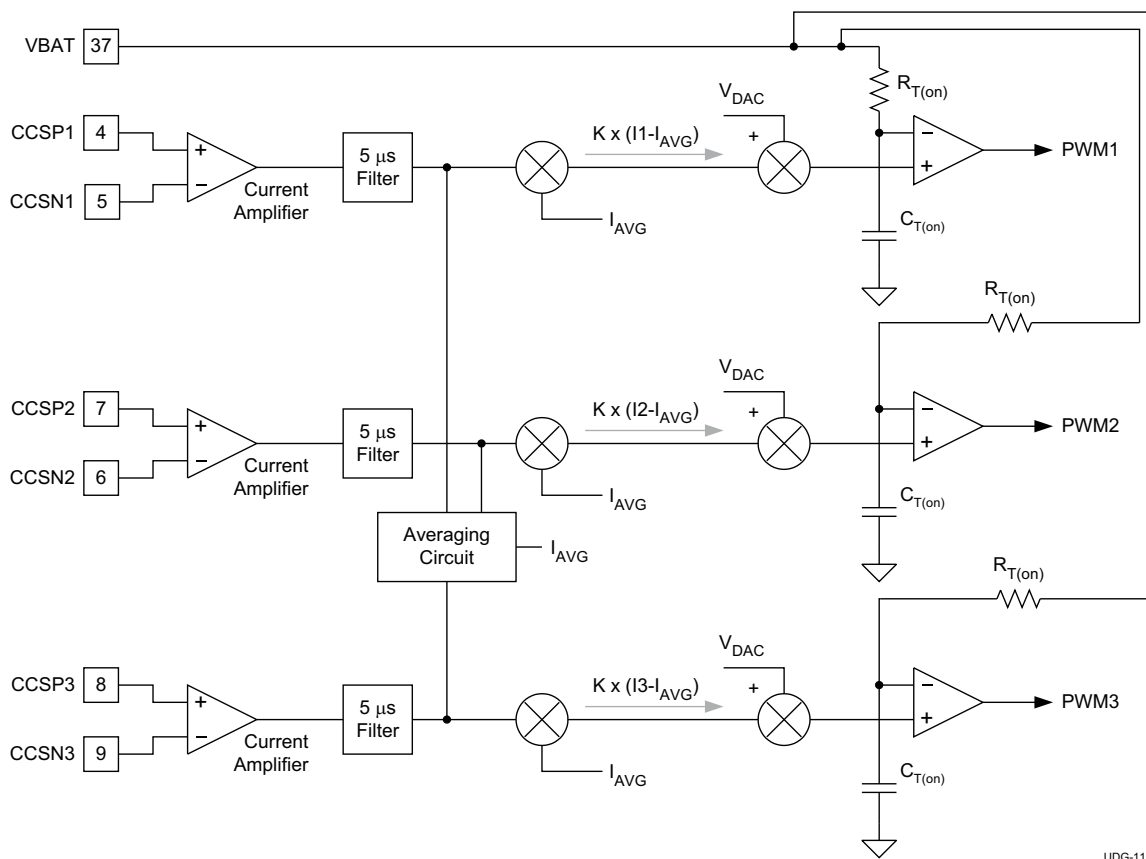

**Figure 69. Schematic Representation of AutoBalance Current Sharing**

## Dynamic VID and Power-State Changes

In IMVP-7, there are 3 basic types of VID changes:

- SetVID-Fast
- SetVID-Slow
- SetVID-Decay

*SetVID-Fast* change and a *SetVID-Slow* change automatically puts the power state in PS0. A *SetVID-Decay* change automatically puts the power state in PS2.



The CPU operates in the maximum phase mode when it is in PS0. This means when the CPU channel of the controller is configured as 3-phase, all 3 phases are active in PS0. When configured in 2-phase mode, the two phases are active in PS0. But in PS1, PS2 and PS3, the operation is in single-phase mode. Additionally, the CPU channel in PS0 mode operates in forced continuous conduction mode (FCCM). But in PS1, PS2 and PS3, the CPU channel operates in diode emulation (DE) mode for additional power savings and higher efficiency.

The single-phase GPU section always operates in diode emulation (DE) mode in all PS states.

The slew rate for a *SetVID-Fast* is the slew rate set at the SLEWA pin. This slew rate is defined in the [ELECTRICAL CHARACTERISTICS](#) table. The *SetVID-Slow* is ¼ of the *SetVID-Fast* slew rate. On a *SetVID-Decay* the output voltage decays by the rate of the load current or 1/8 of the slew rate whichever is slower.

Additionally, on a *SetVID-Fast* change for a VID-up transition, the gain of the  $g_M$  amplifier is increased to speed up the response of the output voltage to meet the Intel timing requirement. So, it is possible to observe an overshoot at the output voltage on a VID-up transition. This overshoot is allowed by the Intel specification.

**Table 4. VID**

VID 7	VID 6	VID 5	VID 4	VID 3	VID 2	VID 1	VID 0	HEX	V <sub>DAC</sub>
0	0	0	0	0	0	0	0	00	0.000
0	0	0	0	0	0	0	1	01	0.250
0	0	0	0	0	0	1	0	02	0.255
0	0	0	0	0	0	1	1	03	0.260
0	0	0	0	0	1	0	0	04	0.265
0	0	0	0	0	1	0	1	05	0.270
0	0	0	0	0	1	1	0	06	0.275
0	0	0	0	0	1	1	1	07	0.280
0	0	0	0	1	0	0	0	08	0.285
0	0	0	0	1	0	0	1	09	0.290
0	0	0	0	1	0	1	0	0A	0.295
0	0	0	0	1	0	1	1	0B	0.300
0	0	0	0	1	1	0	0	0C	0.305
0	0	0	0	1	1	0	1	0D	0.310
0	0	0	0	1	1	1	0	0E	0.315
0	0	0	0	1	1	1	1	0F	0.320
0	0	0	1	0	0	0	0	10	0.325
0	0	0	1	0	0	0	1	11	0.330
0	0	0	1	0	0	1	0	12	0.335
0	0	0	1	0	0	1	1	13	0.340
0	0	0	1	0	1	0	0	14	0.345
0	0	0	1	0	1	0	1	15	0.350
0	0	0	1	0	1	1	0	16	0.355
0	0	0	1	0	1	1	1	17	0.360
0	0	0	1	1	0	0	0	18	0.365
0	0	0	1	1	0	0	1	19	0.370
0	0	0	1	1	0	1	0	1A	0.375
0	0	0	1	1	0	1	1	1B	0.380
0	0	0	1	1	1	0	0	1C	0.385
0	0	0	1	1	1	0	1	1D	0.390
0	0	0	1	1	1	1	0	1E	0.395
0	0	0	1	1	1	1	1	1F	0.400

**Table 4. VID (continued)**

0	0	1	0	0	0	0	0	20	0.405
0	0	1	0	0	0	0	1	21	0.410
0	0	1	0	0	0	1	0	22	0.415
0	0	1	0	0	0	1	1	23	0.420
0	0	1	0	0	1	0	0	24	0.425
0	0	1	0	0	1	0	1	25	0.430
0	0	1	0	0	1	1	0	26	0.435
0	0	1	0	0	1	1	1	27	0.440
0	0	1	0	1	0	0	0	28	0.445
0	0	1	0	1	0	0	1	29	0.450
0	0	1	0	1	0	1	0	2A	0.455
0	0	1	0	1	0	1	1	2B	0.460
0	0	1	0	1	1	0	0	2C	0.465
0	0	1	0	1	1	0	1	2D	0.470
0	0	1	0	1	1	1	0	2E	0.475
0	0	1	0	1	1	1	1	2F	0.480
0	0	1	1	0	0	0	0	30	0.485
0	0	1	1	0	0	0	1	31	0.490
0	0	1	1	0	0	1	0	32	0.495
0	0	1	1	0	0	1	1	33	0.500
0	0	1	1	0	1	0	0	34	0.505
0	0	1	1	0	1	0	1	35	0.510
0	0	1	1	0	1	1	0	36	0.515
0	0	1	1	0	1	1	1	37	0.520
0	0	1	1	1	0	0	0	38	0.525
0	0	1	1	1	0	0	1	39	0.530
0	0	1	1	1	0	1	0	3A	0.535
0	0	1	1	1	0	1	1	3B	0.540
0	0	1	1	1	1	0	0	3C	0.545
0	0	1	1	1	1	0	1	3D	0.550
0	0	1	1	1	1	1	0	3E	0.555
0	0	1	1	1	1	1	1	3F	0.560
0	1	0	0	0	0	0	0	40	0.565
0	1	0	0	0	0	0	1	41	0.570
0	1	0	0	0	0	1	0	42	0.575

**TPS51640A, TPS59640, TPS59641**

SLUSAQ2–JANUARY 2012

[www.ti.com](http://www.ti.com)
**Table 4. VID (continued)**

0	1	0	0	0	0	1	1	43	0.580
0	1	0	0	0	1	0	0	44	0.585
0	1	0	0	0	1	0	1	45	0.590
0	1	0	0	0	1	1	0	46	0.595
0	1	0	0	0	1	1	1	47	0.600
0	1	0	0	1	0	0	0	48	0.605
0	1	0	0	1	0	0	1	49	0.610
0	1	0	0	1	0	1	0	4A	0.615
0	1	0	0	1	0	1	1	4B	0.620
0	1	0	0	1	1	0	0	4C	0.625
0	1	0	0	1	1	0	1	4D	0.630
0	1	0	0	1	1	1	0	4E	0.635
0	1	0	0	1	1	1	1	4F	0.640
0	1	0	1	0	0	0	0	50	0.645
0	1	0	1	0	0	0	1	51	0.650
0	1	0	1	0	0	1	0	52	0.655
0	1	0	1	0	0	1	1	53	0.660
0	1	0	1	0	1	0	0	54	0.665
0	1	0	1	0	1	0	1	55	0.670
0	1	0	1	0	1	1	0	56	0.675
0	1	0	1	0	1	1	1	57	0.680
0	1	0	1	1	0	0	0	58	0.685
0	1	0	1	1	0	0	1	59	0.690
0	1	0	1	1	0	1	0	5A	0.695
0	1	0	1	1	0	1	1	5B	0.700
0	1	0	1	1	1	0	0	5C	0.705
0	1	0	1	1	1	0	1	5D	0.710
0	1	0	1	1	1	1	0	5E	0.715
0	1	0	1	1	1	1	1	5F	0.720
0	1	1	0	0	0	0	0	60	0.725
0	1	1	0	0	0	0	1	61	0.730
0	1	1	0	0	0	1	0	62	0.735
0	1	1	0	0	0	1	1	63	0.740
0	1	1	0	0	1	0	0	64	0.745
0	1	1	0	0	1	0	1	65	0.750
0	1	1	0	0	1	1	0	66	0.755
0	1	1	0	0	1	1	1	67	0.760
0	1	1	0	1	0	0	0	68	0.765
0	1	1	0	1	0	0	1	69	0.770
0	1	1	0	1	0	1	0	6A	0.775
0	1	1	0	1	0	1	1	6B	0.780
0	1	1	0	1	1	0	0	6C	0.785
0	1	1	0	1	1	0	1	6D	0.790
0	1	1	0	1	1	1	0	6E	0.795
0	1	1	0	1	1	1	1	6F	0.800
0	1	1	1	0	0	0	0	70	0.805
0	1	1	1	0	0	0	1	71	0.810
0	1	1	1	0	0	1	0	72	0.815

**Table 4. VID (continued)**

0	1	1	1	0	0	1	1	73	0.820
0	1	1	1	0	1	0	0	74	0.825
0	1	1	1	0	1	0	1	75	0.830
0	1	1	1	0	1	1	0	76	0.835
0	1	1	1	0	1	1	1	77	0.840
0	1	1	1	1	0	0	0	78	0.845
0	1	1	1	1	0	0	1	79	0.850
0	1	1	1	1	0	1	0	7A	0.855
0	1	1	1	1	0	1	1	7B	0.860
0	1	1	1	1	1	0	0	7C	0.865
0	1	1	1	1	1	0	1	7D	0.870
0	1	1	1	1	1	1	0	7E	0.875
0	1	1	1	1	1	1	1	7F	0.880
1	0	0	0	0	0	0	0	80	0.885
1	0	0	0	0	0	0	1	81	0.890
1	0	0	0	0	0	1	0	82	0.895
1	0	0	0	0	0	1	1	83	0.900
1	0	0	0	0	1	0	0	84	0.905
1	0	0	0	0	1	0	1	85	0.910
1	0	0	0	0	1	1	0	86	0.915
1	0	0	0	0	1	1	1	87	0.920
1	0	0	0	1	0	0	0	88	0.925
1	0	0	0	1	0	0	1	89	0.930
1	0	0	0	1	0	1	0	8A	0.935
1	0	0	0	1	0	1	1	8B	0.940
1	0	0	0	1	1	0	0	8C	0.945
1	0	0	0	1	1	0	1	8D	0.950
1	0	0	0	1	1	1	0	8E	0.955
1	0	0	0	1	1	1	1	8F	0.960
1	0	0	1	0	0	0	0	90	0.965
1	0	0	1	0	0	0	1	91	0.970
1	0	0	1	0	0	1	0	92	0.975
1	0	0	1	0	0	1	1	93	0.980
1	0	0	1	0	1	0	0	94	0.985
1	0	0	1	0	1	0	1	95	0.990
1	0	0	1	0	1	1	0	96	0.995
1	0	0	1	0	1	1	1	97	1.000
1	0	0	1	1	0	0	0	98	1.005
1	0	0	1	1	0	0	1	99	1.010
1	0	0	1	1	0	1	0	9A	1.015
1	0	0	1	1	0	1	1	9B	1.020
1	0	0	1	1	1	0	0	9C	1.025
1	0	0	1	1	1	0	1	9D	1.030
1	0	0	1	1	1	1	0	9E	1.035
1	0	0	1	1	1	1	1	9F	1.040
1	0	1	0	0	0	0	0	A0	1.045
1	0	1	0	0	0	0	1	A1	1.050
1	0	1	0	0	0	1	0	A2	1.055

**Table 4. VID (continued)**

1	0	1	0	0	0	1	1	A3	1.060
1	0	1	0	0	1	0	0	A4	1.065
1	0	1	0	0	1	0	1	A5	1.070
1	0	1	0	0	1	1	0	A6	1.075
1	0	1	0	0	1	1	1	A7	1.080
1	0	1	0	1	0	0	0	A8	1.085
1	0	1	0	1	0	0	1	A9	1.090
1	0	1	0	1	0	1	0	AA	1.095
1	0	1	0	1	0	1	1	AB	1.100
1	0	1	0	1	1	0	0	AC	1.105
1	0	1	0	1	1	0	1	AD	1.110
1	0	1	0	1	1	1	0	AE	1.115
1	0	1	0	1	1	1	1	AF	1.120
1	0	1	1	0	0	0	0	B0	1.125
1	0	1	1	0	0	0	1	B1	1.130
1	0	1	1	0	0	1	0	B2	1.135
1	0	1	1	0	0	1	1	B3	1.140
1	0	1	1	0	1	0	0	B4	1.145
1	0	1	1	0	1	0	1	B5	1.150
1	0	1	1	0	1	1	0	B6	1.155
1	0	1	1	0	1	1	1	B7	1.160
1	0	1	1	1	0	0	0	B8	1.165
1	0	1	1	1	0	0	1	B9	1.170
1	0	1	1	1	0	1	0	BA	1.175
1	0	1	1	1	0	1	1	BB	1.180
1	0	1	1	1	1	0	0	BC	1.185
1	0	1	1	1	1	0	1	BD	1.190
1	0	1	1	1	1	1	0	BE	1.195
1	0	1	1	1	1	1	1	BF	1.200
	1	0	0	0	0	0	0	C0	1.205
1	1	0	0	0	0	0	1	C1	1.210
1	1	0	0	0	0	1	0	C2	1.215
1	1	0	0	0	0	1	1	C3	1.220
1	1	0	0	0	1	0	0	C4	1.225
1	1	0	0	0	1	0	1	C5	1.230
1	1	0	0	0	1	1	0	C6	1.235
1	1	0	0	0	1	1	1	C7	1.240
1	1	0	0	1	0	0	0	C8	1.245
1	1	0	0	1	0	0	1	C9	1.250
1	1	0	0	1	0	1	0	CA	1.255
1	1	0	0	1	0	1	1	CB	1.260
1	1	0	0	1	1	0	0	CC	1.265
1	1	0	0	1	1	0	1	CD	1.270
1	1	0	0	1	1	1	0	CE	1.275
1	1	0	0	1	1	1	1	CF	1.280
1	1	0	1	0	0	0	0	D0	1.285
1	1	0	1	0	0	0	1	D1	1.290
1	1	0	1	0	0	1	0	D2	1.295

**Table 4. VID (continued)**

1	1	0	1	0	0	1	1	D3	1.300
1	1	0	1	0	1	0	0	D4	1.305
1	1	0	1	0	1	0	1	D5	1.310
1	1	0	1	0	1	1	0	D6	1.315
1	1	0	1	0	1	1	1	D7	1.320
1	1	0	1	1	0	0	0	D8	1.325
1	1	0	1	1	0	0	1	D9	1.330
1	1	0	1	1	0	1	0	DA	1.335
1	1	0	1	1	0	1	1	DB	1.340
1	1	0	1	1	1	0	0	DC	1.345
1	1	0	1	1	1	0	1	DD	1.350
1	1	0	1	1	1	1	0	DE	1.355
1	1	0	1	1	1	1	1	DF	1.360
1	1	1	0	0	0	0	0	E0	1.365
1	1	1	0	0	0	0	1	E1	1.370
1	1	1	0	0	0	1	0	E2	1.375
1	1	1	0	0	0	1	1	E3	1.380
1	1	1	0	0	1	0	0	E4	1.385
1	1	1	0	0	1	0	1	E5	1.390
1	1	1	0	0	1	1	0	E6	1.395
1	1	1	0	0	1	1	1	E7	1.400
1	1	1	0	1	0	0	0	E8	1.405
1	1	1	0	1	0	0	1	E9	1.410
1	1	1	0	1	0	1	0	EA	1.415
1	1	1	0	1	0	1	1	EB	1.420
1	1	1	0	1	1	0	0	EC	1.425
1	1	1	0	1	1	0	1	ED	1.430
1	1	1	0	1	1	1	0	EE	1.435
1	1	1	0	1	1	1	1	EF	1.440
1	1	1	1	0	0	0	0	F0	1.445
1	1	1	1	0	0	0	1	F1	1.450
1	1	1	1	0	0	1	0	F2	1.455
1	1	1	1	0	0	1	1	F3	1.460
1	1	1	1	0	1	0	0	F4	1.465
1	1	1	1	0	1	0	1	F5	1.470
1	1	1	1	0	1	1	0	F6	1.475
1	1	1	1	0	1	1	1	F7	1.480
1	1	1	1	1	0	0	0	F8	1.485
1	1	1	1	1	0	0	1	F9	1.490
1	1	1	1	1	0	1	0	FA	1.495
1	1	1	1	1	0	1	1	FB	1.500
1	1	1	1	1	1	0	0	FC	1.505
1	1	1	1	1	1	0	1	FD	1.510
1	1	1	1	1	1	1	0	FE	1.515
1	1	1	1	1	1	1	1	FF	1.520

## Gate Driver

The TPS51640A, TPS59640, and TPS59641 incorporate two internal strong, high-performance gate drives with adaptive cross-conduction protection. These drivers are for two phases in the CPU channel. The third phase of the CPU and the single-phase GPU channel require external drivers.

The internal driver in these devices uses the state of the CDLx and CSWx pins to be sure the high-side or low-side FET is OFF before turning the other ON. Fast logic and high drive currents (up to 8-A typical) quickly charge and discharge FET gates to minimize dead-time to increase efficiency. The high-side gate driver also includes an integrated boost FET instead of merely a diode to increase the effective drive voltage for higher efficiency. A zero-crossing detection logic, which detects the switch-node voltage before turning OFF the low-side FET, is used to minimize losses during DCM operation.

## Input Under Voltage Protection (5V and 3.3V)

The TPS51640A, TPS59640, and TPS59641 continuously monitor the voltage on the V5DRV, V5 and V3R3 pin to be sure the value is high enough to bias the device properly and provide sufficient gate drive potential to maintain high efficiency. The converter starts with approximately 4.4-V and has a nominal 200 mV of hysteresis. The input ( $V_{BAT}$ ) does not have a UVLO function, so the circuit operates with power inputs as low as approximately  $3 \times V_{CORE}$ .

## Power Good (CPGOOD and GPGOOD)

These devices have two open-drain power good pins that follow the requirements for IMVP-7. CPGOOD is used for the CPU channel output voltage and GPGOOD is used for the GPU channel output voltage. Both of these signals are active high. The upper and the lower limits for the output voltage for xPGOOD active are:

- Upper:  $V_{DAC} + 220 \text{ mV}$
- Lower:  $V_{DAC} - 315 \text{ mV}$

xPGOOD goes inactive (low) as soon as the VR\_ON pin is pulled low or an undervoltage condition on V5 or V3R3 is detected. The xPGOOD signals are masked during DAC transitions to prevent false triggering during voltage slewing.

## Output Under Voltage Protection

Output undervoltage protection works in conjunction with the current protection described below. If  $V_{CORE}$  drops below the low PGOOD threshold, then the drivers are turned OFF until VR\_ON is cycled.

## Overcurrent Protection

The TPS51640A, TPS59640, and TPS59641 use a *valley* current limiting scheme, so the ripple current must be considered. The DC current value at OCP is the OCP limit value plus half of the ripple current. Current limiting occurs on a phase-by-phase and pulse-by-pulse basis. If the voltage between xCSPx and xCSNx is above the OCP value, the converter delays the next ON pulse until it drops below the OCP limit. For inductor current sensing circuits, the voltage between xCSPx and xCSNx is the inductor DCR value multiplied by the resistor divider which is part of the NTC compensation network. As a result, a wide range of OCP values can be obtained by changing the resistor divider value. In general, use the highest OCP setting possible with the least attenuation in the resistor divider to provide as much signal to the device as possible. This provides the best performance for all parameters related to current feedback.

In OCP mode, the voltage drops until the UVP limit is reached. Then, the converter sets the xPGOOD to inactive, and the drivers are turned OFF. The converter remains in this state until the device is reset by the VR\_ON.

## Overvoltage Protection

An OVP condition is detected when  $V_{CORE}$  is more than 220 mV greater than  $V_{DAC}$ . In this case, the converter sets xPGOOD inactive, and turns ON the drive for the Low-side FET. The converter remains in this state until the device is reset by cycling VR\_ON. However, because of the dynamic nature of IMVP-7 systems, the +220 mV OVP threshold is *blanked* much of the time. In order to provide protection to the processor 100% of the time, there is a second OVP level fixed at 1.7 V which is always active. If the fixed OVP condition is detected, the PGOOD are forced inactive and the low-side FETs are turned ON. The converter remains in this state until VR\_ON is cycled.

## Over Temperature Protection

Two types of thermal protection are provided in these devices:

- VR\_HOT
- Thermal Shutdown

### $\overline{\text{VR\_HOT}}$

The  $\overline{\text{VR\_HOT}}$  signal is an Intel-defined open-drain signal that is used to protect the  $V_{\text{CORE}}$  power chain. To use  $\overline{\text{VR\_HOT}}$ , place an NTC thermistor at the hottest area of the CPU channel and connect it from C\_THERM pin to GND. Similarly for GPU channel, place the NTC thermistor at the hottest area and connect it from G\_THERM to GND. Also, connect a resistor from VREF to G\_THERM and C\_THERM. As the temperature increases, the xTHERM voltage drops below the THERM threshold,  $\overline{\text{VR\_HOT}}$  is activated. A small capacitor may be connected to the xTHERM pins for high frequency noise filtering.

lists the thermal zone register bits based on the xTHERM pin voltage.

**Table 5. Thermal Zone Register Bits**

OUTPUT IS SHUTDOWN	$\overline{\text{VR\_HOT}}$ ASSERTED	SVID ALERT ASSERTED	xTHERM THRESHOLD VOLTAGE FOR THE TEMPERATURE ZONE REGISTER BITS TO BE ASSERTED.					
			b5	b4	b3	b2	b1	b0
410 mV	455 mV	458 mV	523 mV	559 mV	598 mV	638 mV	680 mV	783 mV

### Thermal Shutdown

When the xTHERM pin voltage continues to drop even after  $\overline{\text{VR\_HOT}}$  is asserted, the drivers turn OFF and the output is shutdown. These devices also have an internal temperature sensor. When the temperature reaches a nominal 155°C, the device shuts down until the temperature cools approximately 20°C. Then, the circuit can be re-started by cycling VR\_ON.

### Current Monitor, IMON

The TPS51640A, TPS59640, and TPS59641 includes a current monitor (IMON) function each for CPU channel and GPU channel. The current monitor puts out an analog voltage proportional to the output current on the xIMON pins.

The current monitor function is tied with the OCP selection resistors. The  $R_{\text{COCP}}$  and  $R_{\text{GOCP}}$  are resistors to GND from COCP-I and GOCP-I respectively to select the OCP levels.  $R_{\text{CIMON}}$  is the resistor from CIMON to COCP-I to set the CIMON gain. Similarly,  $R_{\text{GIMON}}$  is the resistor from GIMON to GOCP-I to set the GIMON gain.

The calculation for the CIMON voltage is shown in [Equation 2](#). The calculation for the GIMON voltages is shown in [Equation 3](#).

$$V_{\text{CIMON}} = A_{\text{CS}} \times \left( 1 + \frac{R_{\text{CIMON}}}{R_{\text{COCP}}} \right) \times \sum V_{\text{CCSn}} \quad (2)$$

$$V_{\text{GIMON}} = A_{\text{CS}} \times \left( 1 + \frac{R_{\text{GIMON}}}{R_{\text{GOCP}}} \right) \times V_{\text{GCS}}$$

where

- $A_{\text{CS}}$  is given in the [ELECTRICAL CHARACTERISTICS](#) table
  - $\sum V_{\text{CCSn}}$  is the sum of the DC voltages at the inputs to the CPU channel current sense amplifiers
  - $V_{\text{GCS}}$  is the DC voltage at the GPU channel current sense amplifier
- (3)

For the current monitor function to be stable, connect a 220-nF capacitor from CIMON and GIMON to GND.

### Setting the Maximum Processor Current ( $I_{CC(max)}$ )

The TPS51640 controller allows the user to set the maximum processor current with the multi-function pins CF-IMAX and GF-IMAX. The voltage on the CF-IMAX and GF-IMAX at start-up sets the maximum processor current ( $I_{CC(max)}$ ) for CPU and GPU respectively.

The  $R_{CF}$  and  $R_{GF}$  are resistors to GND from CF-IMAX and GF-IMAX respectively to select the frequency setting.  $R_{CIMAX}$  is the resistor from VREF to CF-IMAX and  $R_{GIMAX}$  is the resistor from VREF to GF-IMAX.

[Equation 4](#) describes the setting the  $I_{CC(max)}$  for the CPU channel and [Equation 5](#) describes the setting the  $I_{CC(max)}$  for the GPU channel.

$$I_{CC(max)CPU} = 255 \times \left( \frac{R_{CF}}{R_{CF} + R_{CIMAX}} \right) \quad (4)$$

$$I_{CC(max)GPU} = 255 \times \left( \frac{R_{GF}}{R_{GF} + R_{GIMAX}} \right) \quad (5)$$

### Internal Driver Bypass Mode

The controller can be configured to operate in internal driver bypass mode for use with DrMOS type devices and driver-integrated PowerBlock devices. Consider the following items when designing for operation in this mode.

- Tie CSW2, CSW1 to V5DRV.
- CDL1 becomes the PWM input to the Phase 1 DrMOS device (or external driver)
- CDL2 becomes the PWM input to the Phase 2 DrMOS device (or external driver)
- $\overline{CSKIP}$  pin becomes the input to the SKIP/FCCM pin of the DrMOS device (or external driver)
- The Phase-2 and Phase-3 DrMOS device (or the external driver) must be configured in FCCM mode.

## DESIGN STEPS

The design procedure using the TPS51640A, TPS59640, and TPS59641 is very simple. An excel-based component value calculation tool is available. Contact your local TI representative to get a copy of the spreadsheet.

The procedure is explained here below with the following design example:

	CPU V <sub>CORE</sub> SPECIFICATIONS	GFX V <sub>CORE</sub> SPECIFICATIONS
No. of phases	3	1
Input Voltage Range	9 V to 20 V	9 V to 20 V
VHFM	0.9 V	1.23 V
I <sub>CC(max)</sub>	94 A	33 A
IDYN-MAX	66 A	20 A
ICC-TDC	52	21.5
Load-line	1.9 mV/A	3.9 mV/A
Fast Slew Rate (minimum)	10 mV/μs	10 mV/μs

### Step One: Select Switching Frequency.

The CPU channel switching frequency is selected by a resistor from CF-IMAX to GND (R<sub>CF</sub>) and GPU channel switching frequency is selected by a resistor from GF-IMAX to GND (R<sub>GF</sub>). The frequency is an approximate frequency and is expected to vary based on load and input voltage.

SELECTION RESISTANCE (kΩ)	CPU CHANNEL FREQUENCY (kHz)	GPU CHANNEL FREQUENCY (kHz)
20	250	275
24	300	330
30	350	385
39	400	440
56	450	495
75	500	550
100	550	605
150	600	660

For this design, the switching frequency for CPU channel is chosen to be 300 kHz and GPU channel is chosen to be 385 kHz. Therefore,

$$R_{CF} = 24 \text{ k}\Omega \text{ and } R_{GF} = 30 \text{ k}\Omega$$

### Step Two: Set I<sub>CC(max)</sub>

The I<sub>CC(max)</sub> is set by the voltage on CF-IMAX for CPU channel and GF-IMAX for GPU channel. This is set by the resistors from VREF to CF-IMAX (R<sub>CMAX</sub>) and from VREF to GF-IMAX (R<sub>GMAX</sub>)

From [Equation 4](#) and [Equation 5](#),

$$R_{CMAX} = 42.2 \text{ k}\Omega \text{ and } R_{GMAX} = 200 \text{ k}\Omega.$$

### Step Three: Set the Slew Rate

The slew rate is set by the voltage setting on SLEWA pin. For a minimum 10 mV/ms slew rate, the voltage on the SLEWA pin must be: 0.8 V. This is set by a resistor divider on SLEWA pin from VREF. The low-side resistor is chosen to be 150 kΩ and the high-side resistor is calculated as 169 kΩ.

### Step Four: Determine inductor value and choose inductor.

Smaller values of inductor have better transient performance but higher ripple and lower efficiency. Higher values have the opposite characteristics. It is common practice to limit the ripple current to 20% to 40% of the maximum current per phase. In this case, we use 30%:

$$I_{P-P} = \frac{94 \text{ A}}{3} \times 0.3 = 9.4 \text{ A}$$

(6)

$$L = \frac{V \times dT}{I_{P-P}} \quad (7)$$

In this equation,

$V = V_{IN-MAX} - V_{HFM} = 19.1V$ ;  $dT = V_{HFM} / (F \times V_{IN-MAX}) = 150 \text{ ns}$ ;  $I_{pp} = 9.4A$ . So, calculating,  $L = 0.304 \mu\text{H}$ .

An inductance value of  $0.36 \mu\text{H}$  is chosen as this is a commonly used inductor for  $V_{CORE}$  application. The inductor must not saturate during peak loading conditions.

$$I_{SAT} = \left( \frac{I_{CC(max)}}{N_{PHASE}} + \frac{I_{P-P}}{2} \right) \times 1.2 = 43.2A \quad (8)$$

The factor of 1.2 allows for current sensing and current limiting tolerances; the factor of 1.25 is the Intel 25% momentary OCP requirement.

The chosen inductor should have the following characteristics:

- An inductance to current curve ratio equal to 1 (or as close possible). Inductor DCR sensing is based on the idea  $L/DCR$  is approximately a constant through the current range of interest.
- Either high saturation or soft saturation.
- Low DCR for improved efficiency, but at least  $0.7 \text{ m}\Omega$  for proper signal levels.
- DCR tolerance as low as possible for load-line accuracy.

For this application, a  $0.36\text{-}\mu\text{H}$ ,  $0.825\text{-m}\Omega$  inductor is chosen. Because the per phase current for GPU is same as CPU, the same inductor for GPU channel is chosen.

**Step Five:** Determine current sensing method.

The TPS51640A, TPS59640, and TPS59641 support both resistor sensing and inductor DCR sensing. Inductor DCR sensing is chosen. For resistor sensing, substitute the resistor value ( $0.75 \text{ m}\Omega$  recommended for a 3-phase 94-A application) for RCS in the subsequent equations and skip Step Four.

**Step Six:** Design the thermal compensation network and selection of OCP.

In most designs, NTC thermistors are used to compensate thermal variations in the resistance of the inductor winding. This winding is generally copper, and so has a resistance coefficient of  $3900 \text{ PPM}/^\circ\text{C}$ . NTC thermistors, on the other hand, have very non-linear characteristics and need two or three resistors to linearize them over the range of interest. The typical DCR circuit is shown in [Figure 70](#).

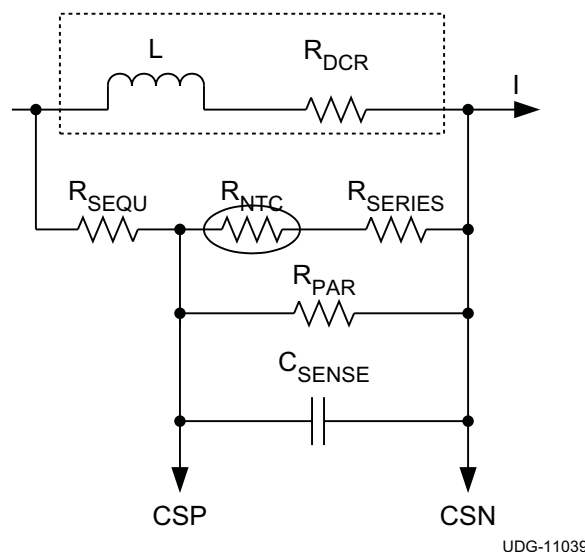

**Figure 70. Typical DCR Sensing Circuit**

In this circuit, the voltage across the  $C_{SENSE}$  exactly equals the voltage across  $R_{DCR}$  when [Equation 9](#) is true.



$$\frac{L}{R_{DCR}} = C_{SENSE} \times R_{EQ}$$

where

- $R_{EQ}$  is the series/parallel combination of  $R_{SEQU}$ ,  $R_{NTC}$ ,  $R_{SERIES}$  and  $R_{PAR}$  (9)

$$R_{EQ} = \frac{R_{P\_N}}{R_{SEQU} + R_{P\_N}} \quad (10)$$

$$R_{P\_N} = \frac{R_{PAR} \times (R_{NTC} + R_{SERIES})}{R_{PAR} + R_{NTC} + R_{SERIES}} \quad (11)$$

$C_{SENSE}$  should be a capacitor type which is stable over temperature. Use X7R or better dielectric (COG preferred).

Since calculating these values by hand is difficult, TI has a spreadsheet using the Excel *Solver* function available to calculate them. Contact a local TI representative to get a copy of the spreadsheet.

In this design, the following values are input to the spreadsheet:

- $L = 0.36 \mu\text{H}$
- $R_{DCR} = 0.825 \text{ m}\Omega$
- Load Line,  $R_{IMVP} = -1.9 \text{ m}\Omega$
- Minimum overcurrent limit = 112 A
- Thermistor  $R_{25} = 100 \text{ k}\Omega$  and "B" value = 4250 k $\Omega$

The spreadsheet then calculates the OCP (overcurrent protection) setting and the values of  $R_{SEQU}$ ,  $R_{SERIES}$ ,  $R_{PAR}$ , and  $C_{SENSE}$ . In this case, the OCP setting is the resistor value selection of 56 k $\Omega$  from COCP-I to GND and GOCP-I to GND. The nearest standard component values are:

- $R_{SEQU} = 17.8 \text{ k}\Omega$ ;
- $R_{SERIES} = 28.7 \text{ k}\Omega$ ;
- $R_{PAR} = 162 \text{ k}\Omega$
- $C_{SENSE} = 33 \text{ nF}$

Note the effective divider ratio for the inductor DCR. The effective current sense resistance ( $R_{CS(\text{eff})}$ ) is shown in [Equation 12](#).

$$R_{CS(\text{eff})} = R_{DCR} \times \frac{R_{P\_N}}{R_{SEQU} + R_{P\_N}}$$

where

- $R_{P\_N}$  is the series/parallel combination of  $R_{NTC}$ ,  $R_{SERIES}$  and  $R_{PAR}$ . (12)

$$R_{GDROOP} = \frac{R_{CS(\text{eff})} \times A_{CS}}{R_{LL} \times G_M} = \frac{0.66 \text{ m}\Omega \times 12}{3.9 \text{ m}\Omega \times 0.497 \text{ mS}} = 4.12 \text{ k}\Omega \quad (13)$$

$R_{CS(\text{eff})}$  is 0.66 m $\Omega$ .

**Step Seven:** Set current monitor (IMON) setting resistor.

After the OCP selection resistor is selected in Step 6, the IMON is set by the resistor from CIMON to COCP-I ( $R_{CIMON}$ ) and GIMON to GOCP-I ( $R_{GIMON}$ ). Based on [Equation 2](#) and [Equation 3](#),

$R_{CIMON} = 71.5 \text{ k}\Omega$  and  $R_{GIMON} = 309 \text{ k}\Omega$

**Step Eight:** Set the load line.

The load-line for CPU channel is set by the resistor,  $R_{CDROOP}$  from CCOMP to VREF. The load-line for GPU channel is set by the resistor,  $R_{GDROOP}$  from the GCOMP pin to VREF. Using the [Equation 1](#), the droop setting resistors are calculated in [Equation 14](#) and [Equation 15](#).

$$R_{CDROOP} = \frac{R_{CS(\text{eff})} \times A_{CS}}{R_{LL} \times G_M} = \frac{0.66 \text{ m}\Omega \times 12}{1.9 \text{ m}\Omega \times 0.497 \text{ mS}} = 8.45 \text{ k}\Omega \quad (14)$$

## TPS51640A, TPS59640, TPS59641

SLUSAQ2–JANUARY 2012

www.ti.com

$$R_{\text{GDROOP}} = \frac{R_{\text{CS(eff)}} \times A_{\text{CS}}}{R_{\text{LL}} \times G_{\text{M}}} = \frac{0.66\text{m}\Omega \times 12}{3.9\text{m}\Omega \times 0.497\text{mS}} = 4.12\text{k}\Omega \quad (15)$$

**Step Nine:** Programming the C THERM and G THERM pins.

The C THERM and G THERM pins should be set so that the resistor divider voltage would be greater than 458 mV at normal operation. For  $\overline{\text{VR\_HOT}}$  to be asserted, the x THERM pin voltage should fall below 458 mV. The NTC resistor from x THERM to GND is chosen as 100 k $\Omega$  with a B of 4250K. With this, for a  $\overline{\text{VR\_HOT}}$  assertion temperature of 105°C, the resistor from x THERM to VREF can be calculated as 15.4 k $\Omega$ .

**Step Ten:** Determine the output capacitor configuration.

For the output capacitor, the Intel Power Delivery guideline gives the output capacitor recommendations. Using these devices, it is possible to meet the load transient with lower capacitance by using the OSR and USR feature. Eight settings are available and this selection has to be tuned based on transient measurement.

## PCB LAYOUT GUIDELINE

### SCHEMATIC REVIEW

Because the voltage and current feedback signals are fully differential it is a good idea to double check their polarity.

1. CCSP1/CCSN1
2. CCSP2/CCSN2
3. CCSP2/CCSN2
4. GCSP/GCSN
5. VCCSENSE to CVFB/VSSSENSE to CGFB (for CPU)
6. VCCGTSENSE to GVFB/VSSGTSENSE to GGFB (for GPU)

Also, note the order of the current sense inputs on Pin 4 to Pin 9 as the second phase has a reverse order.

### CAUTION

Separate noisy driver interface lines from sensitive analog interface lines: (This is the MOST CRITICAL LAYOUT RULE)

The TPS51640A, TPS59640, and TPS59641 make this as easy as possible. The pin-out arrangement for TPS51640A is shown in Figure 71. The driver outputs clearly separated from the sensitive analog and digital circuitry. The driver has a separate PGND and this should be directly connected to the decoupling capacitor that connects from V5DRV to PGND. The thermal pad of the package is the analog ground for these devices and should NOT be connected directly to PGND (Pin 42).

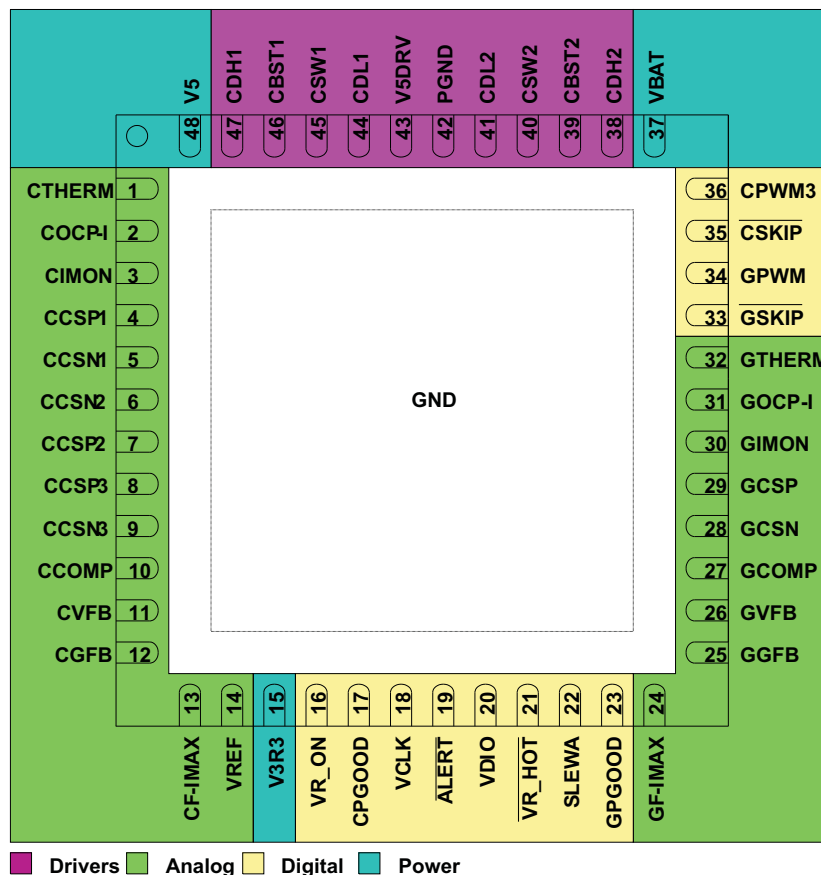
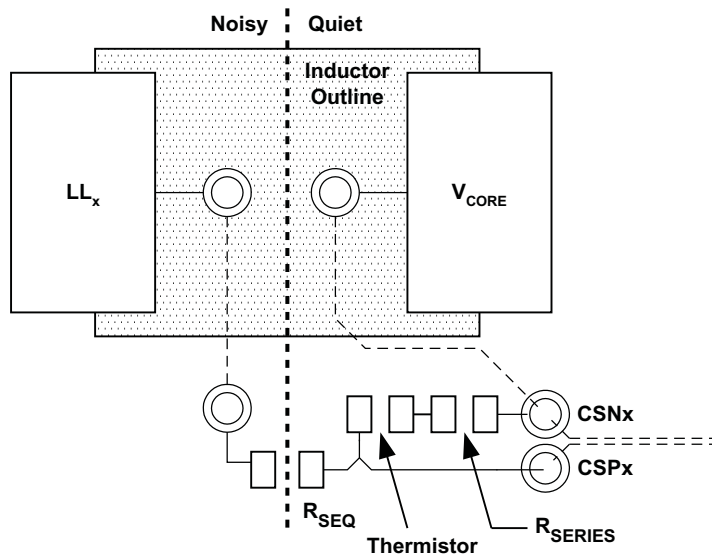

Figure 71. TPS51640A Pin-out Arranged by Pin Function

Given the physical layout of most systems, the current feedback (xCSPx, xCSNx) may have to pass near the power chain. Clean current feedback is required for good load-line, current sharing, and current limiting performance of these devices, so please take the following precautions:

- Make a Kelvin connection to the pads of the resistor or inductor used for current sensing. See [Figure 72](#) for a layout example.
- Run the current feedback signals as a differential pair to the device.
- Run the lines in a quiet layer. Isolate them from noisy signals by a voltage or ground plane.
- Put the compensation capacitor for DCR sensing ( $C_{SENSE}$ ) as close to the CS pins as possible.
- Place any noise filtering capacitors directly underneath these devices and connect to the CS pins with the shortest trace length possible.



UDG-11038

**Figure 72. Make Kelvin Connections to the Inductor for DCR Sensing**

## Minimize High-Current Loops

Figure 73 shows the primary current loops in each phase, numbered in order of importance.

The most important loop to minimize the area of is Loop 1, the path from the input capacitor through the high and low side FETs, and back to the capacitor through ground.

Loop 2 is from the inductor through the output capacitor, ground and Q2. The layout of the low side gate drive (Loops 3a and 3b) is important. The guidelines for gate drive layout are:

- Make the low-side gate drive as short as possible (1 inch or less preferred).
- Make the DRVL width to length ratio of 1:10, wider (1:5) if possible.
- If changing layers is necessary, use at least two vias.

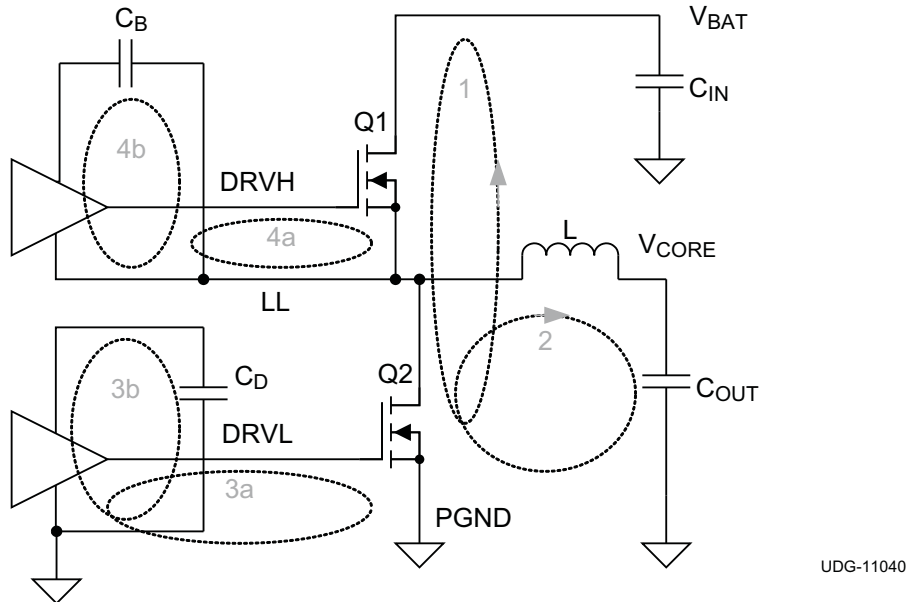

Figure 73. Major Current Loops to Minimize

## Power Chain Symmetry

The TPS51640A, TPS59640, and TPS59641 do not require special care in the layout of the power chain components. This is because independent isolated current feedback is provided. If it is possible to lay out the phases in a symmetrical manner, then please do so. The rule is: the current feedback from each phase needs to be clean of noise and have the same effective current sense resistance.

### Place analog components as close to the device as possible.

Place components close to the device in the following order.

1. CS pin noise filtering components
2. xCOMP pin compensation components
3. Decoupling capacitors for VREF, V3R3, V5
4. xTHERM filter capacitor
5. xIMON capacitor, resistors
6. xF-IMAX resistors

## Grounding Recommendations

These devices have separate analog and power grounds, and a thermal pad. The normal procedure for connecting these is:

- The thermal pad is the analog ground.
- **DO NOT connect the thermal pad to Pin 42 directly** as Pin 42 is the PGND which is the Gate driver Ground.
- Pin 42 (PGND) must be connected directly to the gate driver decoupling capacitor ground terminal.
- Tie the thermal pad (analog ground pin) to a ground island with at least 4 small vias or one large via.
- All the analog components can connect to this analog ground island.
- The analog ground can be connected to any quiet spot on the system ground. A quiet area is defined as a area where no power supply switching currents are likely to flow. This applies to both the  $V_{CORE}$  regulator and other regulators. Use a single point connection from analog ground to the system ground
- Make sure the low-side FET source connection and the decoupling capacitors have plenty of vias.

## Decoupling Recommendations

- Decouple V5IN to PGND with at least a 2.2  $\mu\text{F}$  ceramic capacitor.
- Decouple V5 and V3R3 with 1  $\mu\text{F}$  to AGND with leads as short as possible,
- VREF to AGND with 0.33  $\mu\text{F}$ , with short leads also

## Conductor Widths

- Follow Intel guidelines with respect to the voltage feedback and logic interface connection requirements.
- Maximize the widths of power, ground and drive signal connections.
- For conductors in the power path, be sure there is adequate trace width for the amount of current flowing through the traces.
- Make sure there are sufficient vias for connections between layers. A good guideline is to use a minimum of 1 via per ampere of current.

**PACKAGING INFORMATION**

Orderable Device	Status <sup>(1)</sup>	Package Type	Package Drawing	Pins	Package Qty	Eco Plan <sup>(2)</sup>	Lead/ Ball Finish	MSL Peak Temp <sup>(3)</sup>	Samples (Requires Login)
TPS51640ARSLR	ACTIVE	VQFN	RSL	48	2500	Green (RoHS & no Sb/Br)	CU NIPDAUAG	Level-2-260C-1 YEAR	
TPS51640ARSLT	ACTIVE	VQFN	RSL	48	250	Green (RoHS & no Sb/Br)	CU NIPDAUAG	Level-2-260C-1 YEAR	
TPS59640RSLR	ACTIVE	VQFN	RSL	48	2500	Green (RoHS & no Sb/Br)	CU NIPDAUAG	Level-2-260C-1 YEAR	
TPS59640RSLT	ACTIVE	VQFN	RSL	48	250	Green (RoHS & no Sb/Br)	CU NIPDAUAG	Level-2-260C-1 YEAR	
TPS59641RSLR	ACTIVE	VQFN	RSL	48	2500	Green (RoHS & no Sb/Br)	CU NIPDAUAG	Level-2-260C-1 YEAR	
TPS59641RSLT	ACTIVE	VQFN	RSL	48	250	Green (RoHS & no Sb/Br)	CU NIPDAUAG	Level-2-260C-1 YEAR	

<sup>(1)</sup> The marketing status values are defined as follows:

**ACTIVE:** Product device recommended for new designs.

**LIFEBUY:** TI has announced that the device will be discontinued, and a lifetime-buy period is in effect.

**NRND:** Not recommended for new designs. Device is in production to support existing customers, but TI does not recommend using this part in a new design.

**PREVIEW:** Device has been announced but is not in production. Samples may or may not be available.

**OBSELETE:** TI has discontinued the production of the device.

<sup>(2)</sup> Eco Plan - The planned eco-friendly classification: Pb-Free (RoHS), Pb-Free (RoHS Exempt), or Green (RoHS & no Sb/Br) - please check <http://www.ti.com/productcontent> for the latest availability information and additional product content details.

**TBD:** The Pb-Free/Green conversion plan has not been defined.

**Pb-Free (RoHS):** TI's terms "Lead-Free" or "Pb-Free" mean semiconductor products that are compatible with the current RoHS requirements for all 6 substances, including the requirement that lead not exceed 0.1% by weight in homogeneous materials. Where designed to be soldered at high temperatures, TI Pb-Free products are suitable for use in specified lead-free processes.

**Pb-Free (RoHS Exempt):** This component has a RoHS exemption for either 1) lead-based flip-chip solder bumps used between the die and package, or 2) lead-based die adhesive used between the die and leadframe. The component is otherwise considered Pb-Free (RoHS compatible) as defined above.

**Green (RoHS & no Sb/Br):** TI defines "Green" to mean Pb-Free (RoHS compatible), and free of Bromine (Br) and Antimony (Sb) based flame retardants (Br or Sb do not exceed 0.1% by weight in homogeneous material)

<sup>(3)</sup> MSL, Peak Temp. -- The Moisture Sensitivity Level rating according to the JEDEC industry standard classifications, and peak solder temperature.

**Important Information and Disclaimer:** The information provided on this page represents TI's knowledge and belief as of the date that it is provided. TI bases its knowledge and belief on information provided by third parties, and makes no representation or warranty as to the accuracy of such information. Efforts are underway to better integrate information from third parties. TI has taken and continues to take reasonable steps to provide representative and accurate information but may not have conducted destructive testing or chemical analysis on incoming materials and chemicals. TI and TI suppliers consider certain information to be proprietary, and thus CAS numbers and other limited information may not be available for release.

In no event shall TI's liability arising out of such information exceed the total purchase price of the TI part(s) at issue in this document sold by TI to Customer on an annual basis.



**TAPE AND REEL INFORMATION**
**REEL DIMENSIONS**

**TAPE DIMENSIONS**

A0	Dimension designed to accommodate the component width
B0	Dimension designed to accommodate the component length
K0	Dimension designed to accommodate the component thickness
W	Overall width of the carrier tape
P1	Pitch between successive cavity centers

**TAPE AND REEL INFORMATION**

\*All dimensions are nominal

Device	Package Type	Package Drawing	Pins	SPQ	Reel Diameter (mm)	Reel Width W1 (mm)	A0 (mm)	B0 (mm)	K0 (mm)	P1 (mm)	W (mm)	Pin1 Quadrant
TPS51640ARSLR	VQFN	RSL	48	2500	330.0	16.4	6.3	6.3	1.5	12.0	16.0	Q2
TPS51640ARSLT	VQFN	RSL	48	250	180.0	16.4	6.3	6.3	1.5	12.0	16.0	Q2
TPS59640RSLR	VQFN	RSL	48	2500	330.0	16.4	6.3	6.3	1.5	12.0	16.0	Q2
TPS59640RSLT	VQFN	RSL	48	250	180.0	16.4	6.3	6.3	1.5	12.0	16.0	Q2
TPS59641RSLR	VQFN	RSL	48	2500	330.0	16.4	6.3	6.3	1.5	12.0	16.0	Q2
TPS59641RSLT	VQFN	RSL	48	250	180.0	16.4	6.3	6.3	1.5	12.0	16.0	Q2

**TAPE AND REEL BOX DIMENSIONS**



\*All dimensions are nominal

Device	Package Type	Package Drawing	Pins	SPQ	Length (mm)	Width (mm)	Height (mm)
TPS51640ARSLR	VQFN	RSL	48	2500	367.0	367.0	38.0
TPS51640ARSLT	VQFN	RSL	48	250	210.0	185.0	35.0
TPS59640RSLR	VQFN	RSL	48	2500	367.0	367.0	38.0
TPS59640RSLT	VQFN	RSL	48	250	210.0	185.0	35.0
TPS59641RSLR	VQFN	RSL	48	2500	367.0	367.0	38.0
TPS59641RSLT	VQFN	RSL	48	250	210.0	185.0	35.0

# MECHANICAL DATA

RSL (S-PVQFN-N48)

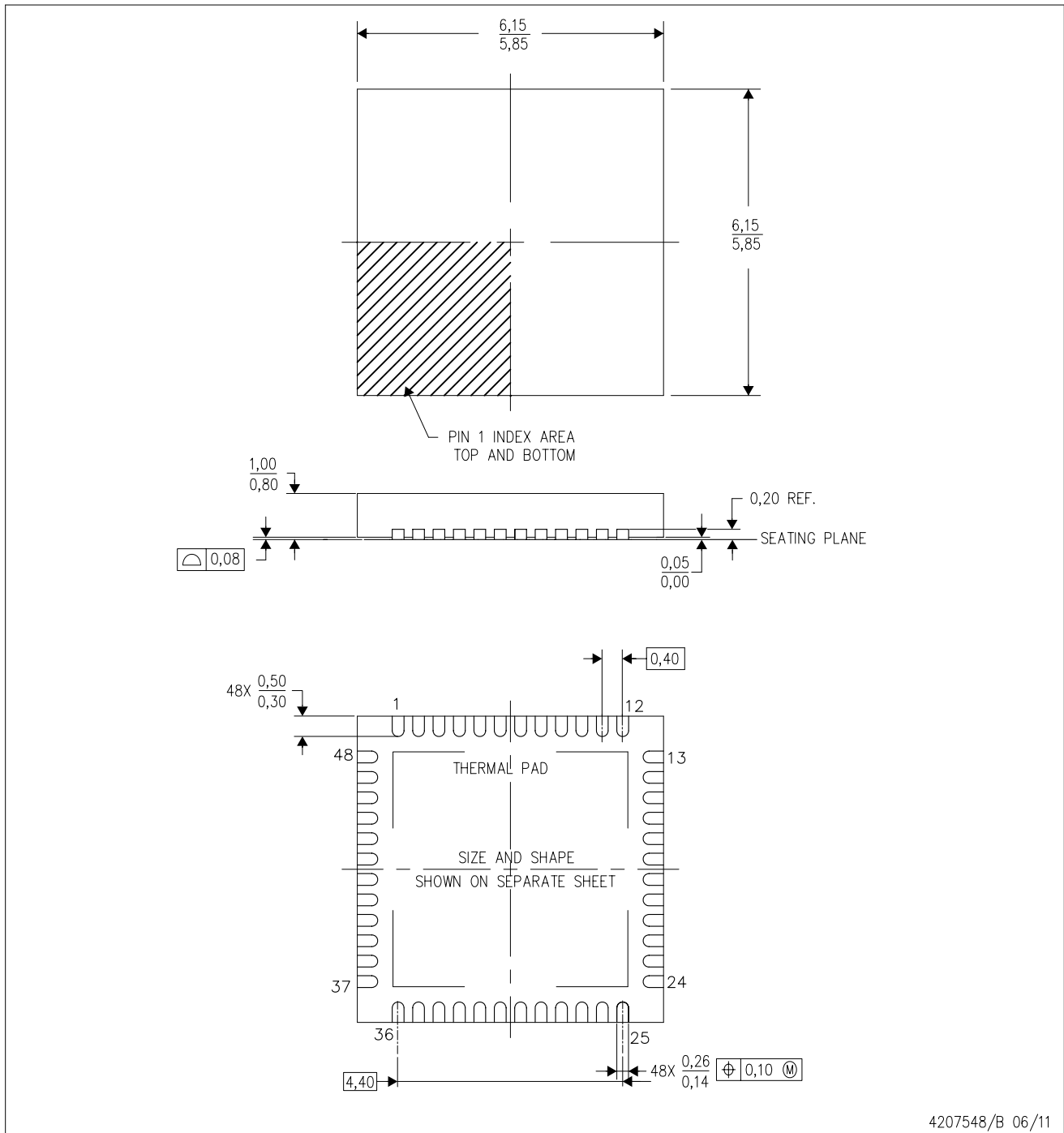
PLASTIC QUAD FLATPACK NO-LEAD



- NOTES:
- All linear dimensions are in millimeters. Dimensioning and tolerancing per ASME Y14.5M-1994.
  - This drawing is subject to change without notice.
  - Quad Flatpack, No-leads (QFN) package configuration.
  - The package thermal pad must be soldered to the board for thermal and mechanical performance.
  - See the additional figure in the Product Data Sheet for details regarding the exposed thermal pad features and dimensions.

# THERMAL PAD MECHANICAL DATA

RSL (S-PVQFN-N48)

PLASTIC QUAD FLATPACK NO-LEAD

## THERMAL INFORMATION

This package incorporates an exposed thermal pad that is designed to be attached directly to an external heatsink. The thermal pad must be soldered directly to the printed circuit board (PCB). After soldering, the PCB can be used as a heatsink. In addition, through the use of thermal vias, the thermal pad can be attached directly to the appropriate copper plane shown in the electrical schematic for the device, or alternatively, can be attached to a special heatsink structure designed into the PCB. This design optimizes the heat transfer from the integrated circuit (IC).

For information on the Quad Flatpack No-Lead (QFN) package and its advantages, refer to Application Report, QFN/SON PCB Attachment, Texas Instruments Literature No. SLUA271. This document is available at [www.ti.com](http://www.ti.com).

The exposed thermal pad dimensions for this package are shown in the following illustration.

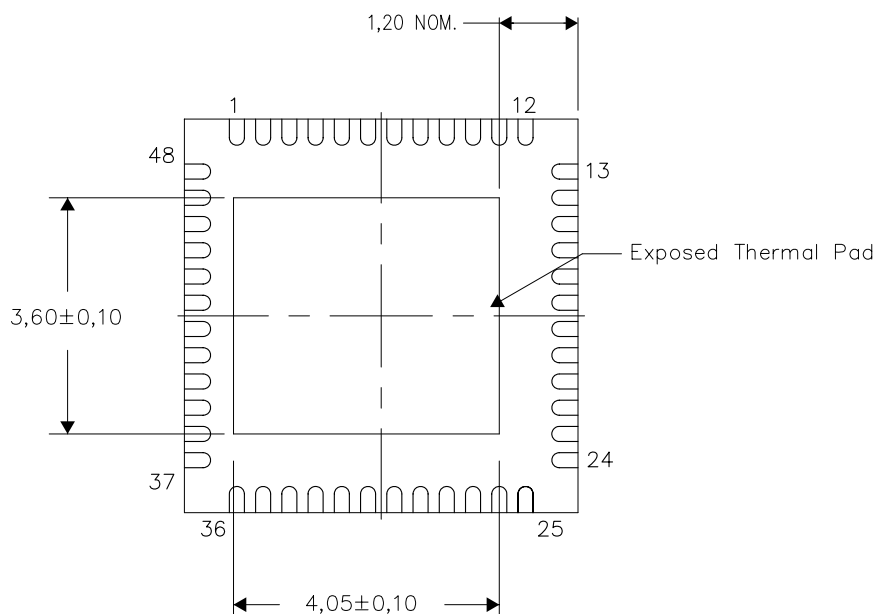

Bottom View

Exposed Thermal Pad Dimensions

4207841-3/N 10/11

NOTE: All linear dimensions are in millimeters

RSL (S-PVQFN-N48)

PLASTIC QUAD FLATPACK NO-LEAD

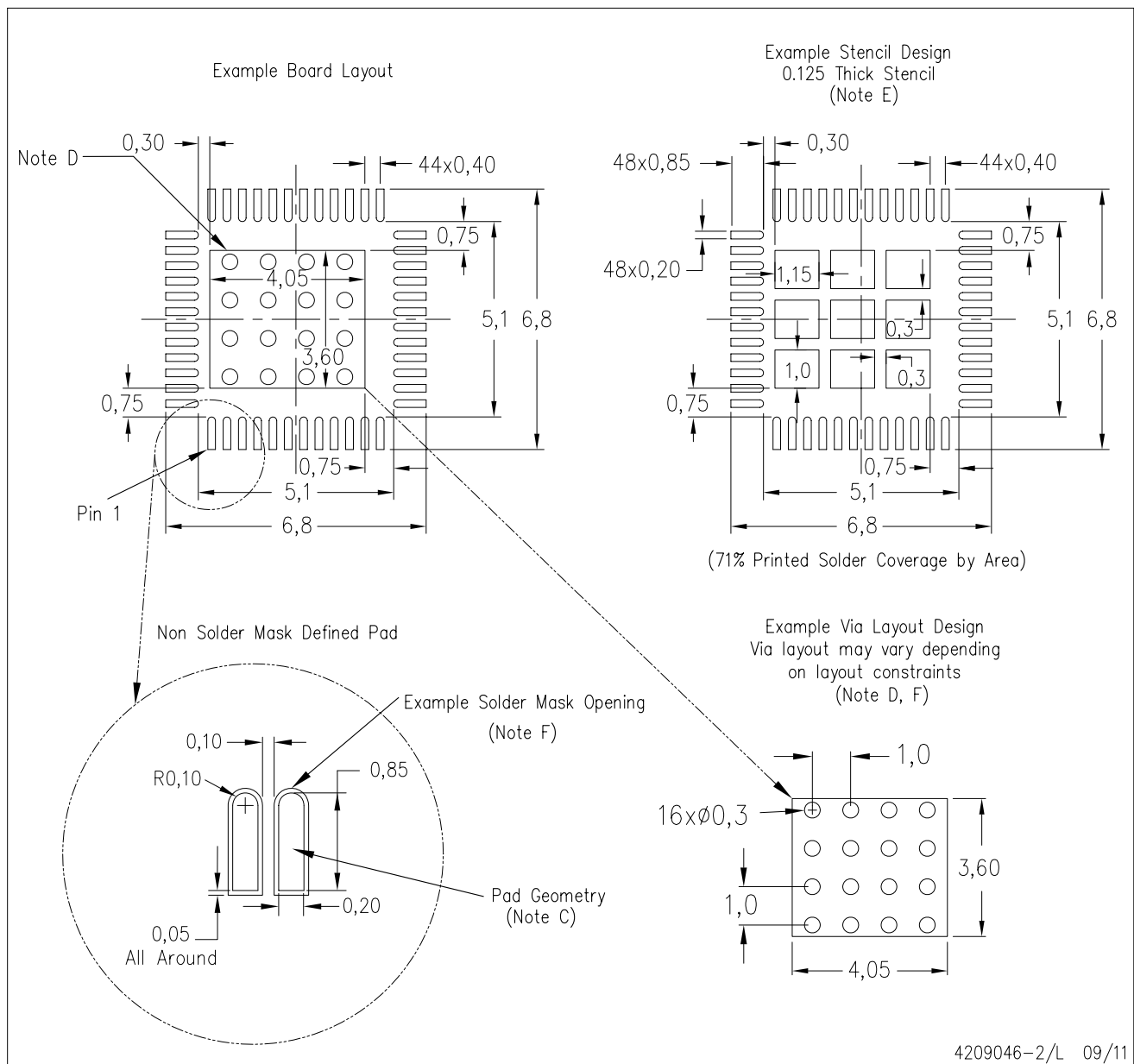

- NOTES:
- All linear dimensions are in millimeters.
  - This drawing is subject to change without notice.
  - Publication IPC-7351 is recommended for alternate designs.
  - This package is designed to be soldered to a thermal pad on the board. Refer to Application Note, QFN/SQN PCB Attachment, Texas Instruments Literature No. SLUA271, and also the Product Data Sheets for specific thermal information, via requirements, and recommended board layout. These documents are available at [www.ti.com](http://www.ti.com) <<http://www.ti.com>>.
  - Laser cutting apertures with trapezoidal walls and also rounding corners will offer better paste release. Customers should contact their board assembly site for stencil design recommendations. Refer to IPC 7525 for stencil design considerations.
  - Customers should contact their board fabrication site for recommended solder mask tolerances and via tenting recommendations for vias placed in the thermal pad.

## IMPORTANT NOTICE

Texas Instruments Incorporated and its subsidiaries (TI) reserve the right to make corrections, enhancements, improvements and other changes to its semiconductor products and services per JESD46C and to discontinue any product or service per JESD48B. Buyers should obtain the latest relevant information before placing orders and should verify that such information is current and complete. All semiconductor products (also referred to herein as "components") are sold subject to TI's terms and conditions of sale supplied at the time of order acknowledgment.

TI warrants performance of its components to the specifications applicable at the time of sale, in accordance with the warranty in TI's terms and conditions of sale of semiconductor products. Testing and other quality control techniques are used to the extent TI deems necessary to support this warranty. Except where mandated by applicable law, testing of all parameters of each component is not necessarily performed.

TI assumes no liability for applications assistance or the design of Buyers' products. Buyers are responsible for their products and applications using TI components. To minimize the risks associated with Buyers' products and applications, Buyers should provide adequate design and operating safeguards.

TI does not warrant or represent that any license, either express or implied, is granted under any patent right, copyright, mask work right, or other intellectual property right relating to any combination, machine, or process in which TI components or services are used. Information published by TI regarding third-party products or services does not constitute a license to use such products or services or a warranty or endorsement thereof. Use of such information may require a license from a third party under the patents or other intellectual property of the third party, or a license from TI under the patents or other intellectual property of TI.

Reproduction of significant portions of TI information in TI data books or data sheets is permissible only if reproduction is without alteration and is accompanied by all associated warranties, conditions, limitations, and notices. TI is not responsible or liable for such altered documentation. Information of third parties may be subject to additional restrictions.

Resale of TI components or services with statements different from or beyond the parameters stated by TI for that component or service voids all express and any implied warranties for the associated TI component or service and is an unfair and deceptive business practice. TI is not responsible or liable for any such statements.

Buyer acknowledges and agrees that it is solely responsible for compliance with all legal, regulatory and safety-related requirements concerning its products, and any use of TI components in its applications, notwithstanding any applications-related information or support that may be provided by TI. Buyer represents and agrees that it has all the necessary expertise to create and implement safeguards which anticipate dangerous consequences of failures, monitor failures and their consequences, lessen the likelihood of failures that might cause harm and take appropriate remedial actions. Buyer will fully indemnify TI and its representatives against any damages arising out of the use of any TI components in safety-critical applications.

In some cases, TI components may be promoted specifically to facilitate safety-related applications. With such components, TI's goal is to help enable customers to design and create their own end-product solutions that meet applicable functional safety standards and requirements. Nonetheless, such components are subject to these terms.

No TI components are authorized for use in FDA Class III (or similar life-critical medical equipment) unless authorized officers of the parties have executed a special agreement specifically governing such use.

Only those TI components which TI has specifically designated as military grade or "enhanced plastic" are designed and intended for use in military/aerospace applications or environments. Buyer acknowledges and agrees that any military or aerospace use of TI components which have **not** been so designated is solely at the Buyer's risk, and that Buyer is solely responsible for compliance with all legal and regulatory requirements in connection with such use.

TI has specifically designated certain components which meet ISO/TS16949 requirements, mainly for automotive use. Components which have not been so designated are neither designed nor intended for automotive use; and TI will not be responsible for any failure of such components to meet such requirements.

### Products

Audio	<a href="http://www.ti.com/audio">www.ti.com/audio</a>
Amplifiers	<a href="http://amplifier.ti.com">amplifier.ti.com</a>
Data Converters	<a href="http://dataconverter.ti.com">dataconverter.ti.com</a>
DLP® Products	<a href="http://www.dlp.com">www.dlp.com</a>
DSP	<a href="http://dsp.ti.com">dsp.ti.com</a>
Clocks and Timers	<a href="http://www.ti.com/clocks">www.ti.com/clocks</a>
Interface	<a href="http://interface.ti.com">interface.ti.com</a>
Logic	<a href="http://logic.ti.com">logic.ti.com</a>
Power Mgmt	<a href="http://power.ti.com">power.ti.com</a>
Microcontrollers	<a href="http://microcontroller.ti.com">microcontroller.ti.com</a>
RFID	<a href="http://www.ti-rfid.com">www.ti-rfid.com</a>
OMAP Mobile Processors	<a href="http://www.ti.com/omap">www.ti.com/omap</a>
Wireless Connectivity	<a href="http://www.ti.com/wirelessconnectivity">www.ti.com/wirelessconnectivity</a>

### Applications

Automotive and Transportation	<a href="http://www.ti.com/automotive">www.ti.com/automotive</a>
Communications and Telecom	<a href="http://www.ti.com/communications">www.ti.com/communications</a>
Computers and Peripherals	<a href="http://www.ti.com/computers">www.ti.com/computers</a>
Consumer Electronics	<a href="http://www.ti.com/consumer-apps">www.ti.com/consumer-apps</a>
Energy and Lighting	<a href="http://www.ti.com/energy">www.ti.com/energy</a>
Industrial	<a href="http://www.ti.com/industrial">www.ti.com/industrial</a>
Medical	<a href="http://www.ti.com/medical">www.ti.com/medical</a>
Security	<a href="http://www.ti.com/security">www.ti.com/security</a>
Space, Avionics and Defense	<a href="http://www.ti.com/space-avionics-defense">www.ti.com/space-avionics-defense</a>
Video and Imaging	<a href="http://www.ti.com/video">www.ti.com/video</a>

**TI E2E Community** [e2e.ti.com](http://e2e.ti.com)