

## FEATURES

- **Controlled Baseline**
  - One Assembly/Test Site, One Fabrication Site
- **Enhanced Diminishing Manufacturing Sources (DMS) Support**
- **Enhanced Product-Change Notification**
- **Qualification Pedigree <sup>(1)</sup>**
- **Complete Pulse-Width Modulation (PWM) Power-Control Circuitry**
- **Completely Synchronized Operation**
- **Internal Undervoltage Lockout Protection**
- **Wide Supply-Voltage Range**
- **Internal Short-Circuit Protection**
- **Oscillator Frequency . . . 500 kHz Max**
- **Variable Dead Time Provides Control Over Total Range**
- **Internal Regulator Provides a Stable 2.5-V Reference Supply**

- (1) Component qualification in accordance with JEDEC and industry standards to ensure reliable operation over an extended temperature range. This includes, but is not limited to, Highly Accelerated Stress Test (HAST) or biased 85/85, temperature cycle, autoclave or unbiased HAST, electromigration, bond intermetallic life, and mold compound life. Such qualification testing should not be viewed as justifying use of this component beyond specified performance and environmental limits.

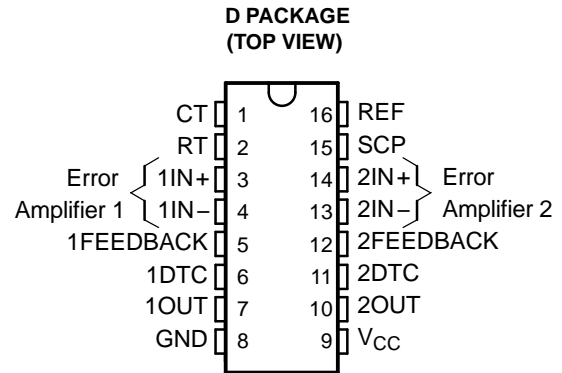

## DESCRIPTION/ORDERING INFORMATION

The TL1451A-EP incorporates on a single monolithic chip all the functions required in the construction of two pulse-width modulation (PWM) control circuits. Designed primarily for power-supply control, the TL1451A-EP contains an on-chip 2.5-V regulator, two error amplifiers, an adjustable oscillator, two dead-time comparators, undervoltage lockout circuitry, and dual common-emitter output transistor circuits.

The uncommitted output transistors provide common-emitter output capability for each controller. The internal amplifiers exhibit a common-mode voltage range from 1.04 V to 1.45 V. The dead-time control (DTC) comparator has no offset unless externally altered and can provide 0% to 100% dead time. The on-chip oscillator can be operated by terminating RT and CT. During low  $V_{CC}$  conditions, the undervoltage lockout control circuit feature locks the outputs off until the internal circuitry is operational.

The TL1451A-EP is characterized for operation from  $-55^{\circ}\text{C}$  to  $125^{\circ}\text{C}$ .

### ORDERING INFORMATION

$T_A$	PACKAGE <sup>(1)</sup>		ORDERABLE PART NUMBER	TOP-SIDE MARKING
$-55^{\circ}\text{C}$ to $125^{\circ}\text{C}$	SOIC – D	Tape and reel	TL1451AMDREP	TL1451EPG4

- (1) Package drawings, standard packing quantities, thermal data, symbolization, and PCB design guidelines are available at [www.ti.com/sc/package](http://www.ti.com/sc/package).



Please be aware that an important notice concerning availability, standard warranty, and use in critical applications of Texas Instruments semiconductor products and disclaimers thereto appears at the end of this data sheet.

FUNCTIONAL BLOCK DIAGRAM

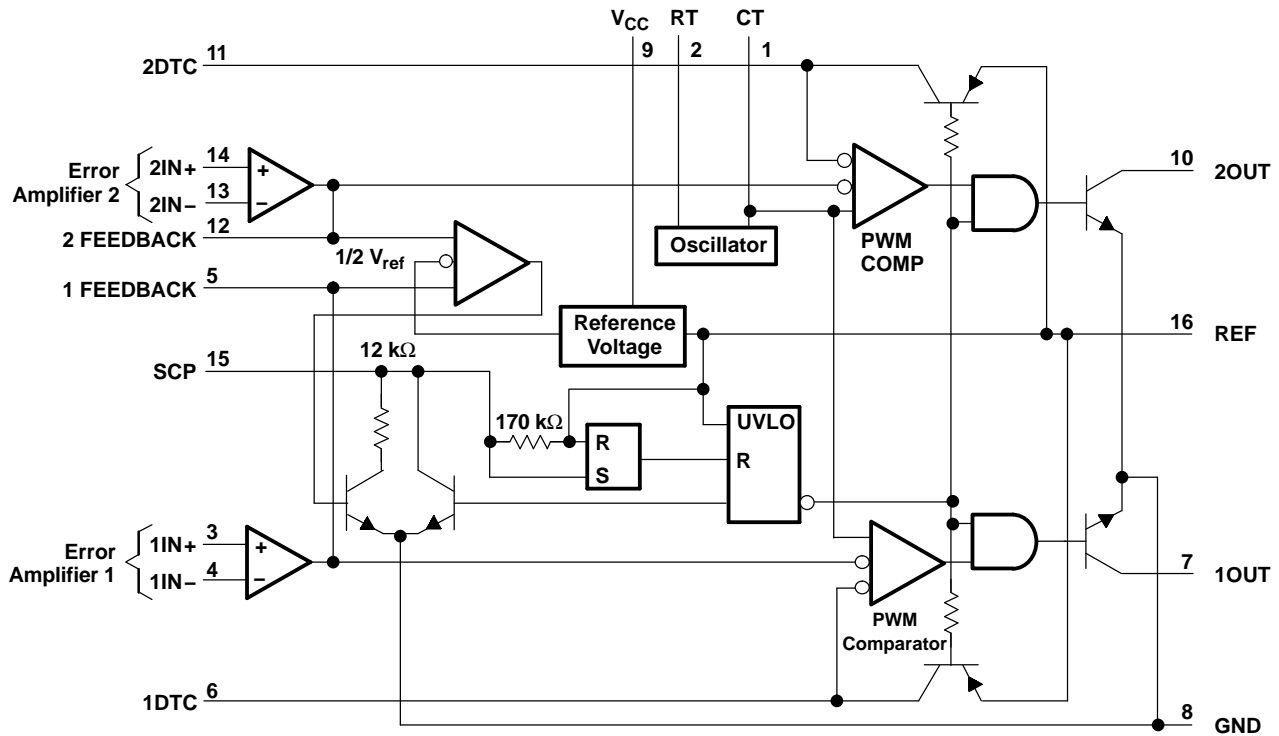

COMPONENT COUNT

Resistors	65
Capacitors	8
Transistors	105
JFETs	18

Absolute Maximum Ratings<sup>(1)</sup>

over operating free-air temperature range

			MIN	MAX	UNIT
V <sub>CC</sub>	Supply voltage			51	V
V <sub>I</sub>	Amplifier input voltage			20	V
V <sub>O</sub>	Collector output voltage			51	V
I <sub>O</sub>	Collector output current			21	mA
	Continuous power total dissipation		See Dissipation Rating Table		
T <sub>A</sub>	Operating free-air temperature range	M suffix	-55	125	°C
T <sub>stg</sub>	Storage temperature range		-65	150	°C
	Lead temperature	1,6 mm (1/16 in) from case for 10 s		260	°C

(1) Stresses beyond those listed under "absolute maximum ratings" may cause permanent damage to the device. These are stress ratings only, and functional operation of the device at these or any other conditions beyond those indicated under "recommended operating conditions" is not implied. Exposure to absolute-maximum-rated conditions for extended periods may affect device reliability.

**Dissipation Ratings**

PACKAGE	$T_A \leq 25^\circ\text{C}$ POWER RATING	DERATING FACTOR ABOVE $T_A = 25^\circ\text{C}$	$T_A = 70^\circ\text{C}$ POWER RATING	$T_A = 85^\circ\text{C}$ POWER RATING	$T_A = 125^\circ\text{C}$ POWER RATING
D	1088 mW	8.7 mW/°C	696 mW	566 mW	218 mW

**Recommended Operating Conditions**

		MIN	MAX	UNIT	
$V_{CC}$	Supply voltage	3.6	50	V	
$V_I$	Amplifier input voltage	1.05	1.45	V	
$V_O$	Collector output voltage		50	V	
$I_O$	Collector output current		20	mA	
	Current into feedback terminal		45	$\mu\text{A}$	
$R_F$	Feedback resistor	100		$\text{k}\Omega$	
$C_T$	Timing capacitor	150	15000	pF	
$R_T$	Timing resistor	5.1	100	$\text{k}\Omega$	
	Oscillator frequency	1	500	kHz	
$T_A$	Operating free-air temperature				
		M suffix	-55	125	°C

**Reference Section Electrical Characteristics**

 over recommended operating free-air temperature range,  $V_{CC} = 6\text{ V}$ ,  $f = 200\text{ kHz}$  (unless otherwise noted)

PARAMETER	TEST CONDITIONS		MIN	TYP <sup>(1)</sup>	MAX	UNIT
Output voltage (pin 16)	$I_O = 1\text{ mA}$	$T_A = 25^\circ\text{C}$	2.4	2.5	2.6	V
		$T_A = \text{MIN and } 125^\circ\text{C}$	2.35	2.46	2.65	
Output voltage change with temperature				-0.63%	$\pm 4\%$ <sup>(2)</sup>	
Input voltage regulation	$V_{CC} = 3.6\text{ V to } 40\text{ V}$	$T_A = 25^\circ\text{C}$		2	12.5	mV
		$T_A = 125^\circ\text{C}$		0.7	15	
		$T_A = \text{MIN}$		0.3	30	
Output voltage regulation	$I_O = 0.1\text{ mA to } 1\text{ mA}$	$T_A = 25^\circ\text{C}$		1	7.5	mV
		$T_A = 125^\circ\text{C}$		0.3	14	
		$T_A = \text{MIN}$		0.3	20	
Short-circuit output current	$V_O = 0$		3	10	30	mA

- (1) All typical values are at  $T_A = 25^\circ\text{C}$ , unless otherwise indicated.  
 (2) These parameters are not production tested.

### Undervoltage Lockout Section Electrical Characteristics

over recommended operating free-air temperature range,  $V_{CC} = 6\text{ V}$ ,  $f = 200\text{ kHz}$  (unless otherwise noted)

PARAMETER	TEST CONDITIONS	MIN	TYP <sup>(1)</sup>	MAX	UNIT
Upper threshold voltage ( $V_{CC}$ )	$T_A = 25^\circ\text{C}$		2.72		V
	$T_A = 125^\circ\text{C}$		1.7		
	$T_A = \text{MIN}$		3.15		
Lower threshold voltage ( $V_{CC}$ )	$T_A = 25^\circ\text{C}$		2.6		V
	$T_A = 125^\circ\text{C}$		1.65		
	$T_A = \text{MIN}$		3.09		
Hysteresis ( $V_{CC}$ )	$T_A = 25^\circ\text{C}$	80	120		mV
	$T_A = 125^\circ\text{C}$	10	50		
	$T_A = \text{MIN}$	10	60		
Reset threshold voltage ( $V_{CC}$ )	$T_A = 25^\circ\text{C}$	1.5			V
	$T_A = 125^\circ\text{C}$	0.95			
	$T_A = \text{MIN}$	1.5			

(1) All typical values are at  $T_A = 25^\circ\text{C}$ , unless otherwise indicated.

### Short-Circuit Protection Control Section Electrical Characteristics

over recommended operating free-air temperature range,  $V_{CC} = 6\text{ V}$ ,  $f = 200\text{ kHz}$  (unless otherwise noted)

PARAMETER	TEST CONDITIONS	MIN	TYP <sup>(1)</sup>	MAX	UNIT
Input threshold voltage (SCP)	$T_A = 25^\circ\text{C}$	650	700	750	mV
	$T_A = 125^\circ\text{C}$	400	478	650	
	$T_A = \text{MIN}$	800	880	950	
Standby voltage (SCP)		140	185	230	mV
Latched input voltage (SCP)	$T_A = 25^\circ\text{C}$		60	120	mV
	$T_A = 125^\circ\text{C}$		70	120	
	$T_A = \text{MIN}$		60	120	
Equivalent timing resistance			170		k $\Omega$
Comparator threshold voltage (FEEDBACK)			1.18		V

(1) All typical values are at  $T_A = 25^\circ\text{C}$ , unless otherwise indicated.

### Oscillator Section Electrical Characteristics

over recommended operating free-air temperature range,  $V_{CC} = 6\text{ V}$ ,  $f = 200\text{ kHz}$  (unless otherwise noted)

PARAMETER	TEST CONDITIONS	MIN	TYP <sup>(1)</sup>	MAX	UNIT
Frequency	$C_T = 330\text{ pF}$ , $R_T = 10\text{ k}\Omega$	$T_A = 25^\circ\text{C}$	200		kHz
		$T_A = 125^\circ\text{C}$	195		
		$T_A = \text{MIN}$	193		
Standard deviation of frequency	$C_T = 330\text{ pF}$ , $R_T = 10\text{ k}\Omega$		2%		
Frequency change with voltage	$V_{CC} = 3.6\text{ V to }40\text{ V}$	$T_A = 25^\circ\text{C}$	1%		
		$T_A = 125^\circ\text{C}$	1%		
		$T_A = \text{MIN}$	3%		
Frequency change with temperature			1.37%	$\pm 10\%$ <sup>(2)</sup>	

(1) All typical values are at  $T_A = 25^\circ\text{C}$ , unless otherwise indicated.

(2) These parameters are not production tested.

**Dead-Time Control Section Electrical Characteristics**

 over recommended operating free-air temperature range,  $V_{CC} = 6\text{ V}$ ,  $f = 200\text{ kHz}$  (unless otherwise noted)

PARAMETER	TEST CONDITIONS	MIN	TYP <sup>(1)</sup>	MAX	UNIT
Input bias current (DTC)	$T_A = 25^\circ\text{C}$			1	$\mu\text{A}$
	$T_A = \text{MIN}$ and $125^\circ\text{C}$			3	
Latch mode (source) current (DTC)		-80	-145		$\mu\text{A}$
Latched input voltage (DTC)	$T_A = 25^\circ\text{C}$	2.3			V
	$T_A = 125^\circ\text{C}$	2.22	2.32		
	$T_A = \text{MIN}$	2.28	2.4		
Input threshold voltage at $f = 10\text{ kHz}$ (DTC)	Zero duty cycle		2.05	2.25 <sup>(2)</sup>	V
	Maximum duty cycle	1.2 <sup>(2)</sup>	1.45		

 (1) All typical values are at  $T_A = 25^\circ\text{C}$ , unless otherwise indicated.

(2) These parameters are not production tested.

**Error-Amplifier Section Electrical Characteristics**

 over recommended operating free-air temperature range,  $V_{CC} = 6\text{ V}$ ,  $f = 200\text{ kHz}$  (unless otherwise noted)

PARAMETER	TEST CONDITIONS	MIN	TYP <sup>(1)</sup>	MAX	UNIT
Input offset voltage	$V_O (\text{FEEDBACK}) = 1.25\text{ V}$	$T_A = 25^\circ\text{C}$		$\pm 7$	mV
		$T_A = 125^\circ\text{C}$		$\pm 10$	
		$T_A = \text{MIN}$		$\pm 12$	
Input offset current	$V_O (\text{FEEDBACK}) = 1.25\text{ V}$	$T_A = 25^\circ\text{C}$		$\pm 100$	nA
		$T_A = 125^\circ\text{C}$		$\pm 100$	
		$T_A = \text{MIN}$		$\pm 200$	
Input bias current	$V_O (\text{FEEDBACK}) = 1.25\text{ V}$	$T_A = 25^\circ\text{C}$	160	500	nA
		$T_A = 125^\circ\text{C}$	100	500	
		$T_A = \text{MIN}$	142	700	
Common-mode input voltage range	$V_{CC} = 3.6\text{ V}$ to $40\text{ V}$	1.05 to 1.45			V
Open-loop voltage amplification	$R_F = 200\text{ k}\Omega$	$T_A = 25^\circ\text{C}$	70	80	dB
		$T_A = 125^\circ\text{C}$	70	80	
		$T_A = \text{MIN}$	64	80	
Unity-gain bandwidth			1.5		MHz
Common-mode rejection ratio		60	80		dB
Positive output voltage swing		2			V
Negative output voltage swing				1	V
Output (sink) current (FEEDBACK)	$V_{ID} = -0.1\text{ V}$ , $V_O = 1.25\text{ V}$	$T_A = 25^\circ\text{C}$	0.5	1.6	mA
		$T_A = 125^\circ\text{C}$	0.4	1.8	
		$T_A = \text{MIN}$	0.3	1.7	
Output (source) current (FEEDBACK)	$V_{ID} = 0.1\text{ V}$ , $V_O = 1.25\text{ V}$	$T_A = 25^\circ\text{C}$	-45	-70	$\mu\text{A}$
		$T_A = 125^\circ\text{C}$	-25	-50	
		$T_A = \text{MIN}$	-15	-70	

 (1) All typical values are at  $T_A = 25^\circ\text{C}$ , unless otherwise indicated.

### Output Section Electrical Characteristics

over recommended operating free-air temperature range,  $V_{CC} = 6\text{ V}$ ,  $f = 200\text{ kHz}$  (unless otherwise noted)

PARAMETER	TEST CONDITIONS	MIN	TYP <sup>(1)</sup>	MAX	UNIT
Collector off-state current	$V_O = 50\text{ V}$			10	$\mu\text{A}$
Output saturation voltage	$T_A = 25^\circ\text{C}$		1.2	2	V
	$T_A = 125^\circ\text{C}$		1.6	2.4	
	$T_A = \text{MIN}$		1.36	2.2	
Short-circuit output current	$V_O = 6\text{ V}$		90		mA

(1) All typical values are at  $T_A = 25^\circ\text{C}$ , unless otherwise indicated.

### PWM Comparator Section Electrical Characteristics

over recommended operating free-air temperature range,  $V_{CC} = 6\text{ V}$ ,  $f = 200\text{ kHz}$  (unless otherwise noted)

PARAMETER	TEST CONDITIONS	MIN	TYP <sup>(1)</sup>	MAX	UNIT
Input threshold voltage at $f = 10\text{ kHz}$ (FEEDBACK)	Zero duty cycle		2.05	2.25 <sup>(2)</sup>	V
	Maximum duty cycle	1.2 <sup>(2)</sup>	1.45		

(1) All typical values are at  $T_A = 25^\circ\text{C}$ , unless otherwise indicated.

(2) These parameters are not production tested.

### Total Device Electrical Characteristics

over recommended operating free-air temperature range,  $V_{CC} = 6\text{ V}$ ,  $f = 200\text{ kHz}$  (unless otherwise noted)

PARAMETER	TEST CONDITIONS	MIN	TYP <sup>(1)</sup>	MAX	UNIT
Standby supply current	Off-state		1.3	1.8	mA
Average supply current	$R_T = 10\text{ k}\Omega$		1.7	2.4	mA

(1) All typical values are at  $T_A = 25^\circ\text{C}$ , unless otherwise indicated.

PARAMETER MEASUREMENT INFORMATION

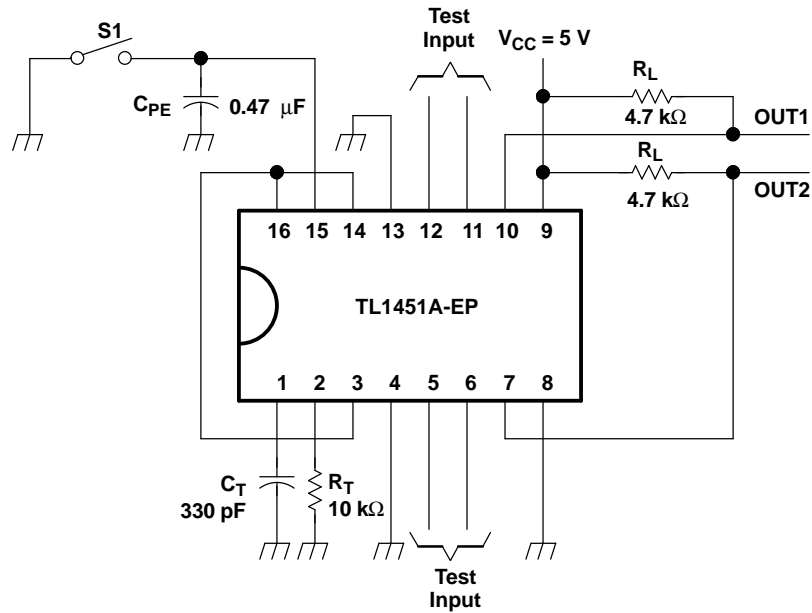
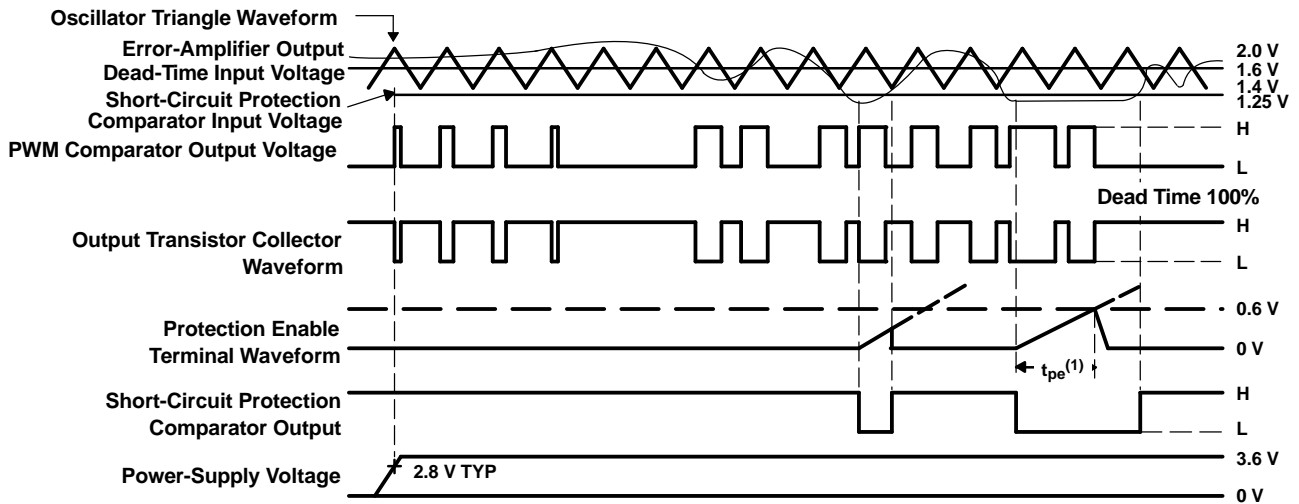

Figure 1. Test Circuit



(1) Protection enable time,  $t_{pe} = (0.051 \times 10^6 \times C_{pe})$  in seconds

Figure 2. TL1451A-EP Timing

TYPICAL CHARACTERISTICS

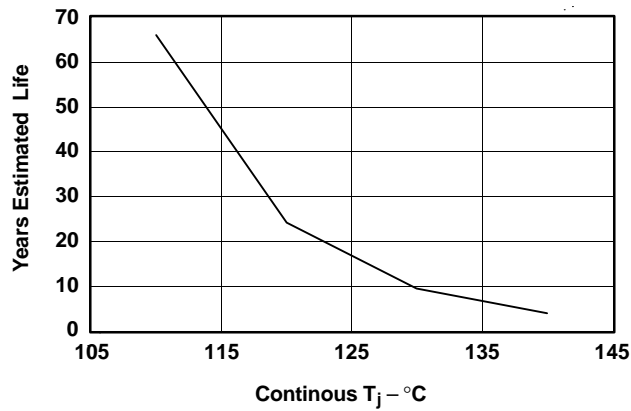

Figure 3. Estimated Devised Life at Elevated Temperatures for Wirebond Voiding Fail Mode

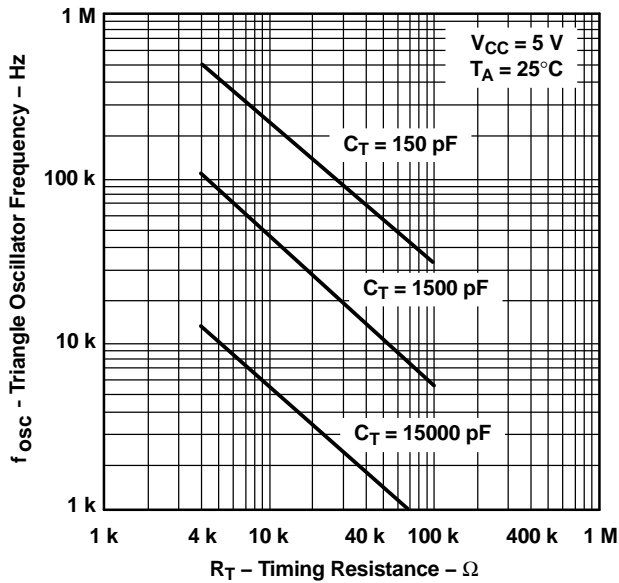

Figure 4. Triangle Oscillator Frequency vs Timing Resistance

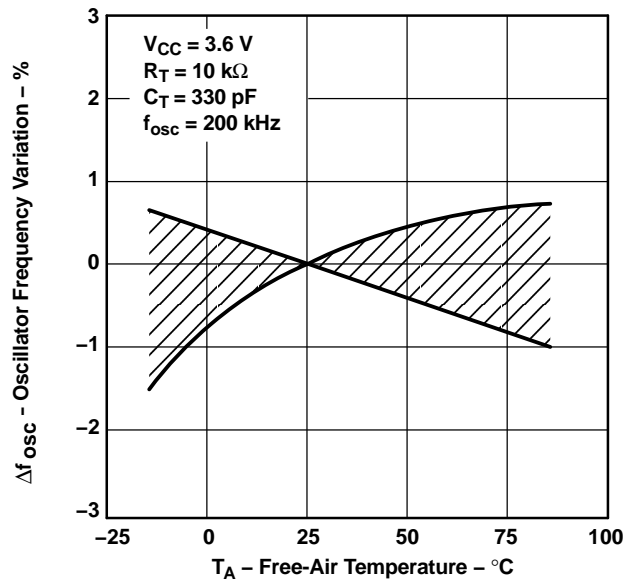

Figure 5. Oscillator Frequency Variation vs Free-Air Temperature



TYPICAL CHARACTERISTICS (continued)

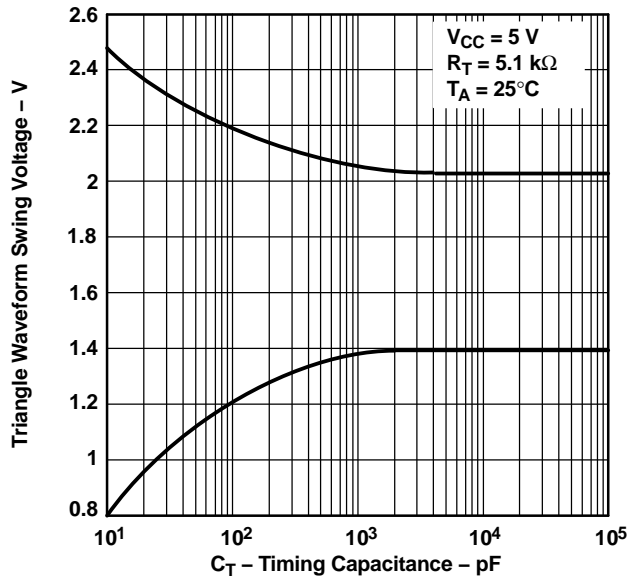

Figure 6. Triangle Waveform Swing Voltage vs Timing Capacitance

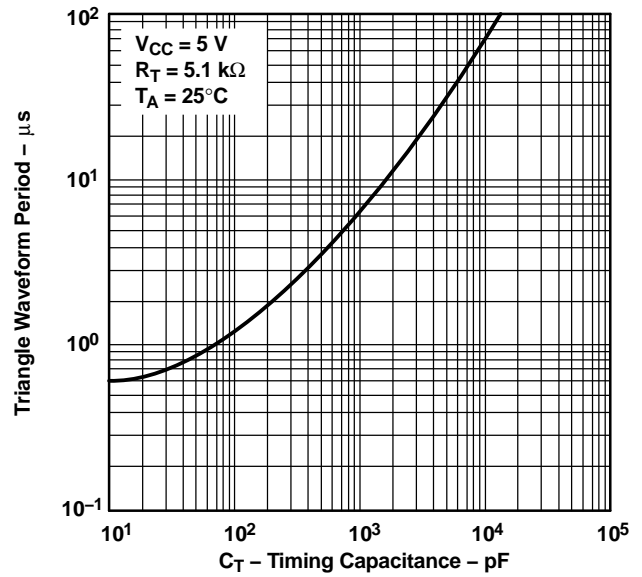

Figure 7. Triangle Waveform Period vs Timing Capacitance

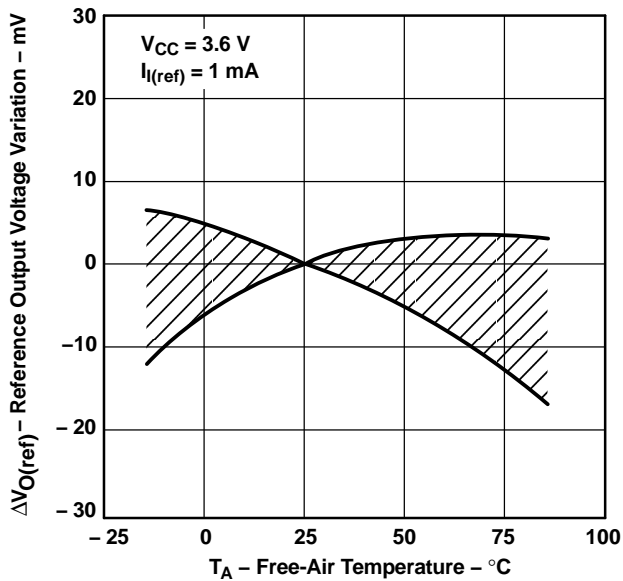

Figure 8. Reference Output Voltage Variation vs Free-Air Temperature

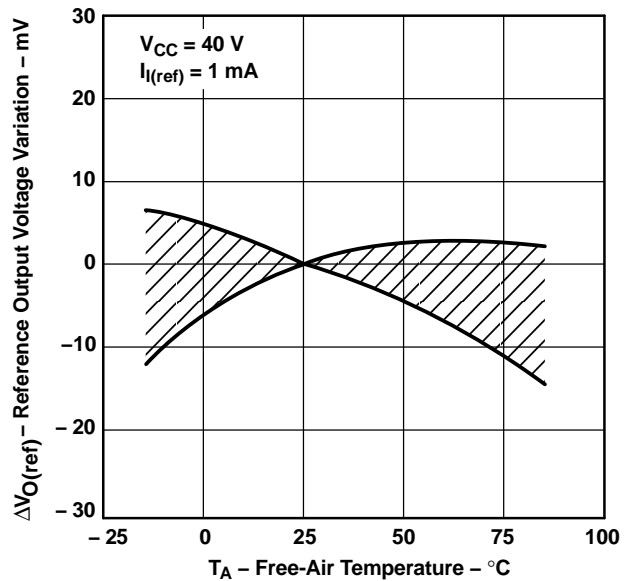

Figure 9. Reference Output Voltage Variation vs Free-Air Temperature

TYPICAL CHARACTERISTICS (continued)

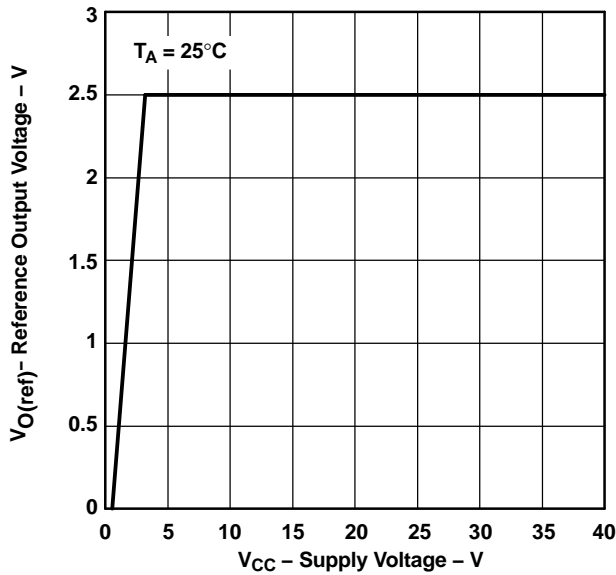

Figure 10. Reference Output Voltage vs Supply Voltage

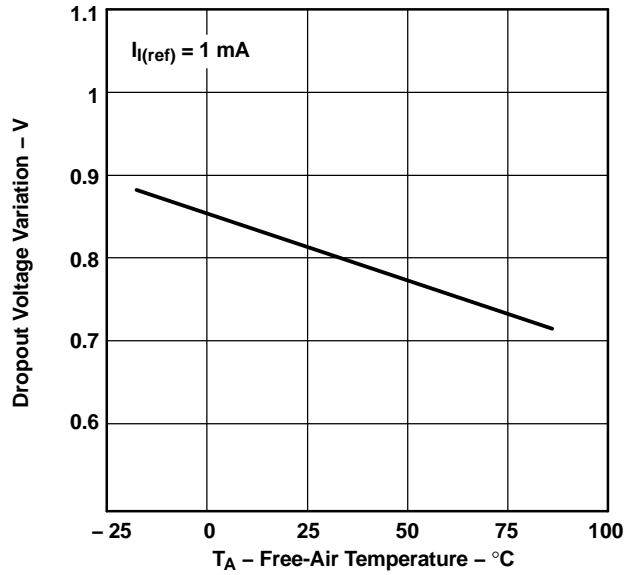

Figure 11. Dropout Voltage Variation vs Free-air Temperature

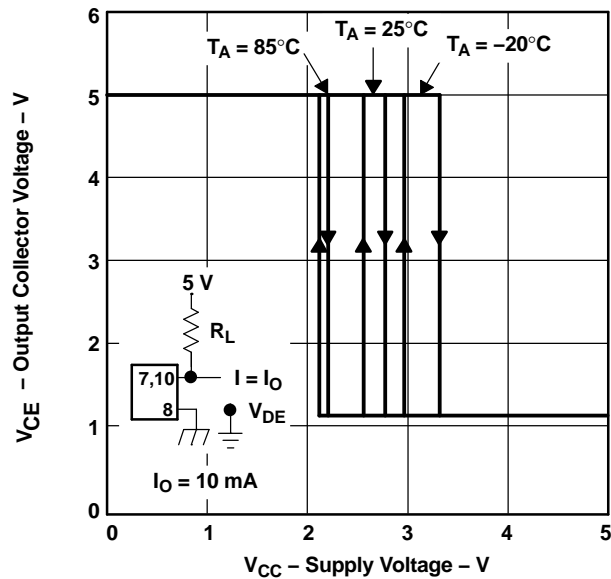

Figure 12. Undervoltage Lockout Hysteresis Characteristics

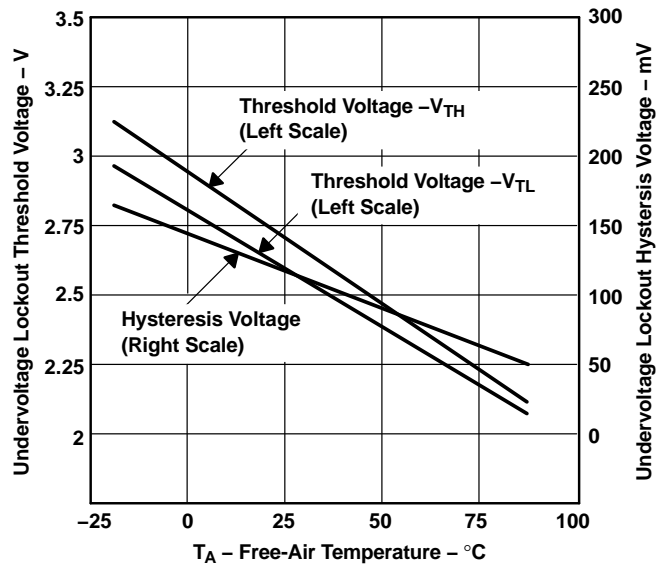

Figure 13. Undervoltage Lockout Characteristics

TYPICAL CHARACTERISTICS (continued)

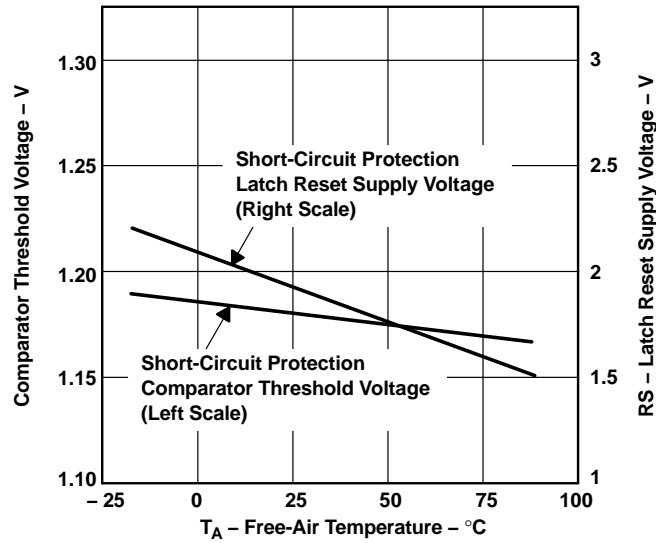

Figure 14. Short-Circuit Protection Characteristics

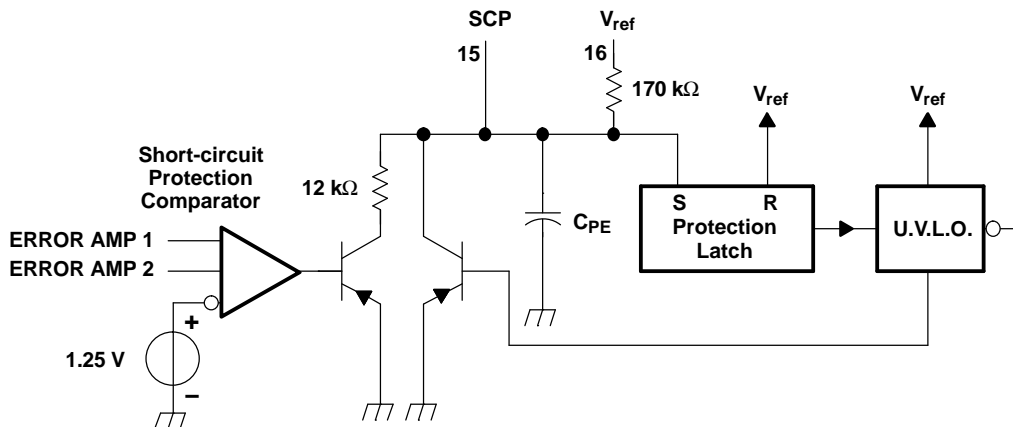
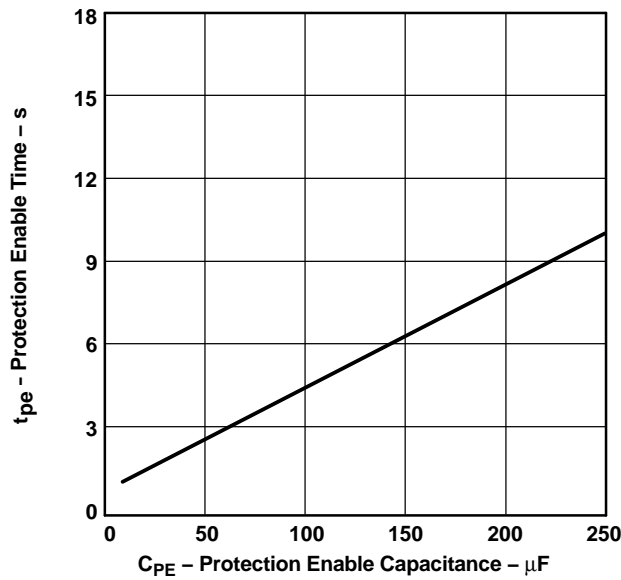

Figure 15. Protection Enable Time vs Protection Enable Capacitance

TYPICAL CHARACTERISTICS (continued)

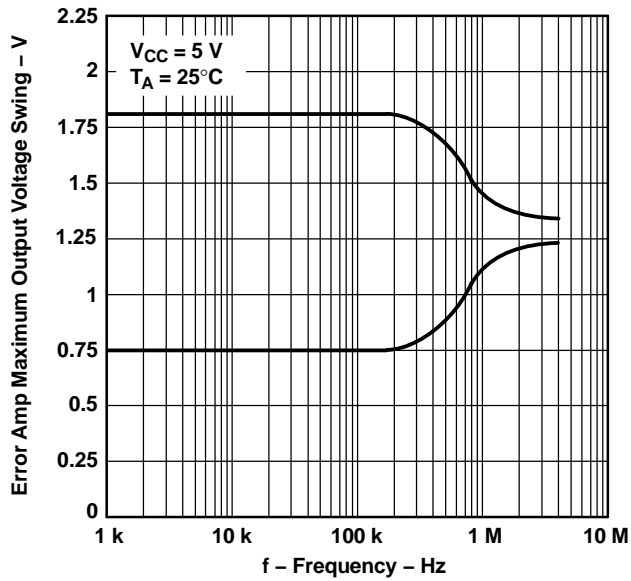

Figure 16. Error Amplifier Maximum Output Voltage Swing vs Frequency

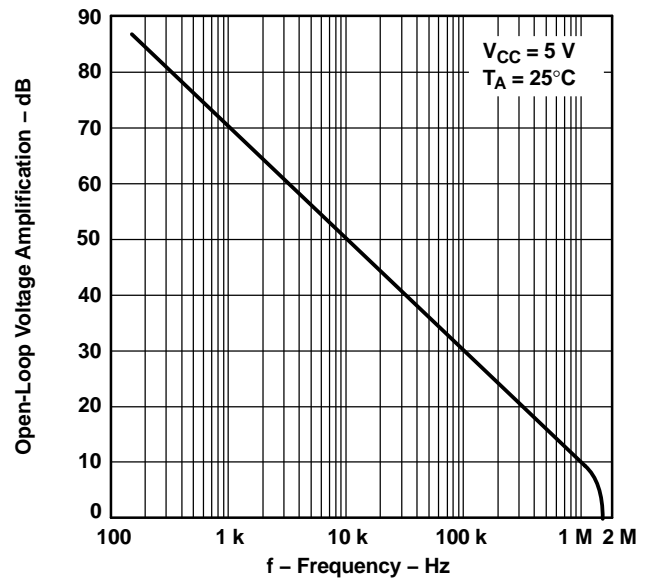

Figure 17. Open-Loop Voltage Amplification vs Frequency

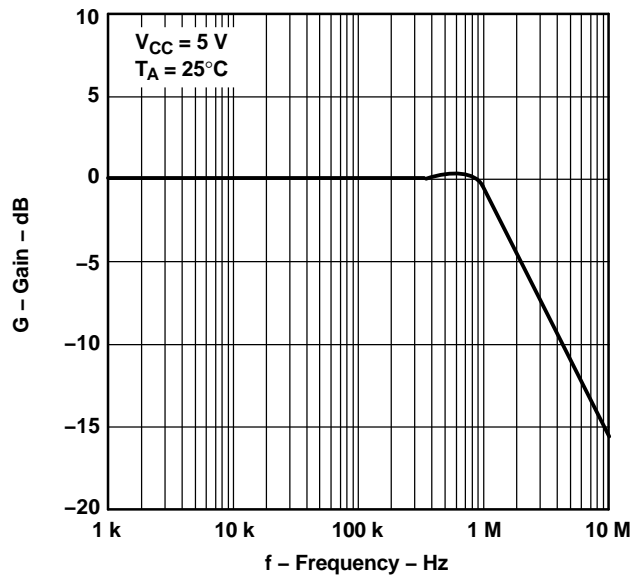
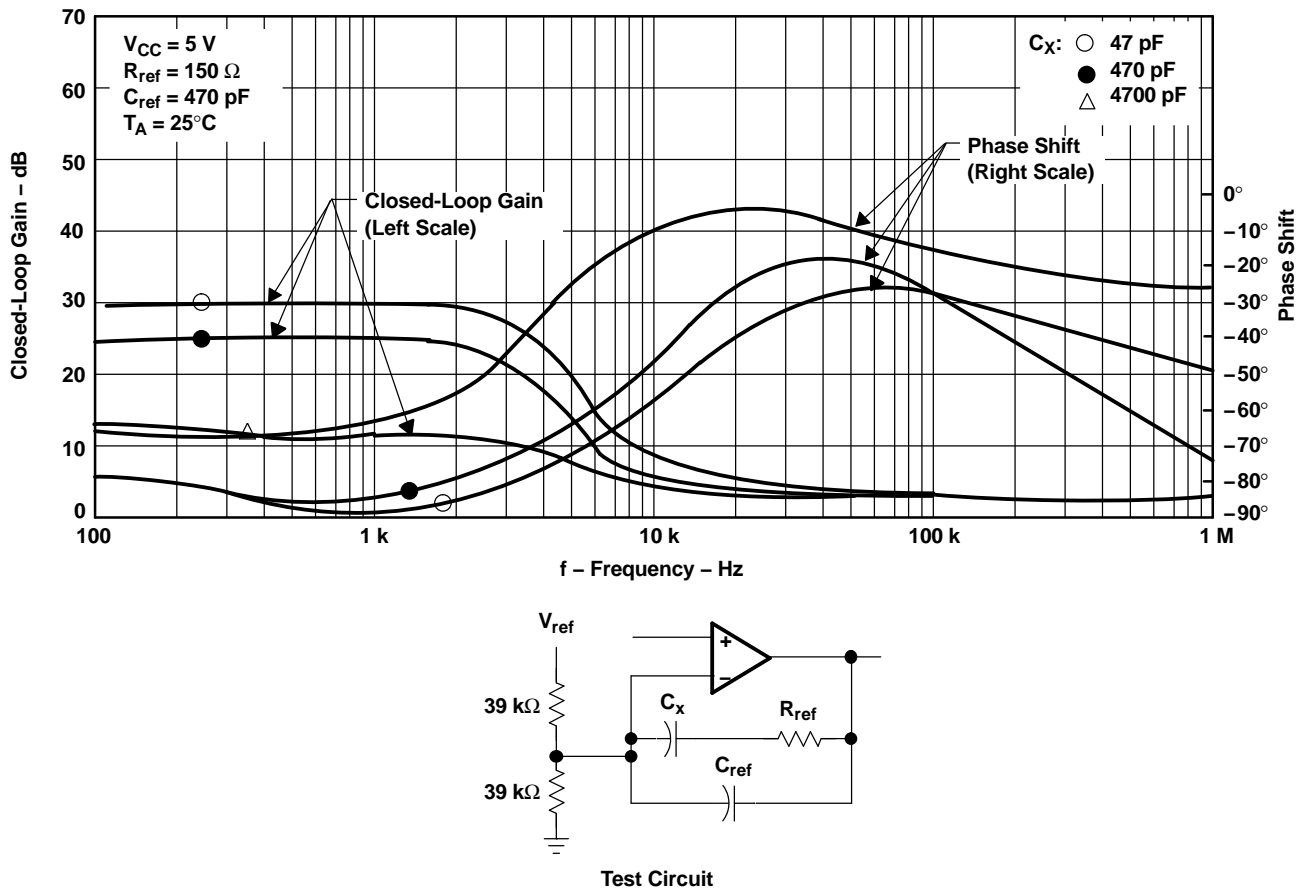

Figure 18. Gain (Amplifier in Unity-Gain Configuration vs Frequency)

**TYPICAL CHARACTERISTICS (continued)**



**Figure 19. Closed-Loop Gain and Phase Shift vs Frequency**

TYPICAL CHARACTERISTICS (continued)

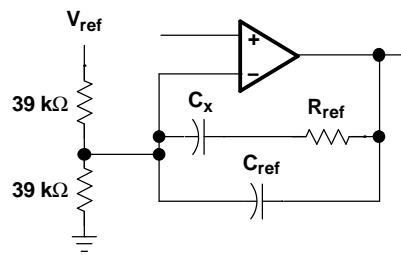
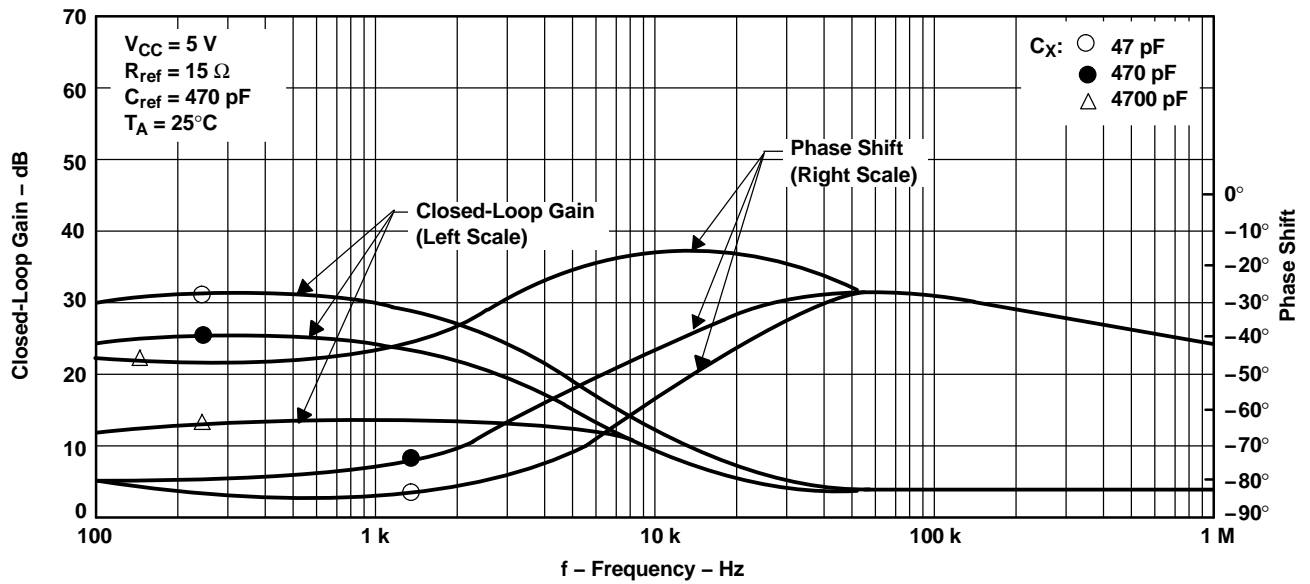

Test Circuit

Figure 20. Closed-Loop Gain and Phase Shift vs Frequency

**TYPICAL CHARACTERISTICS (continued)**

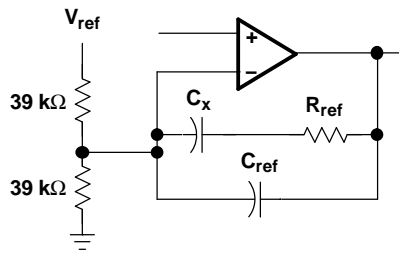
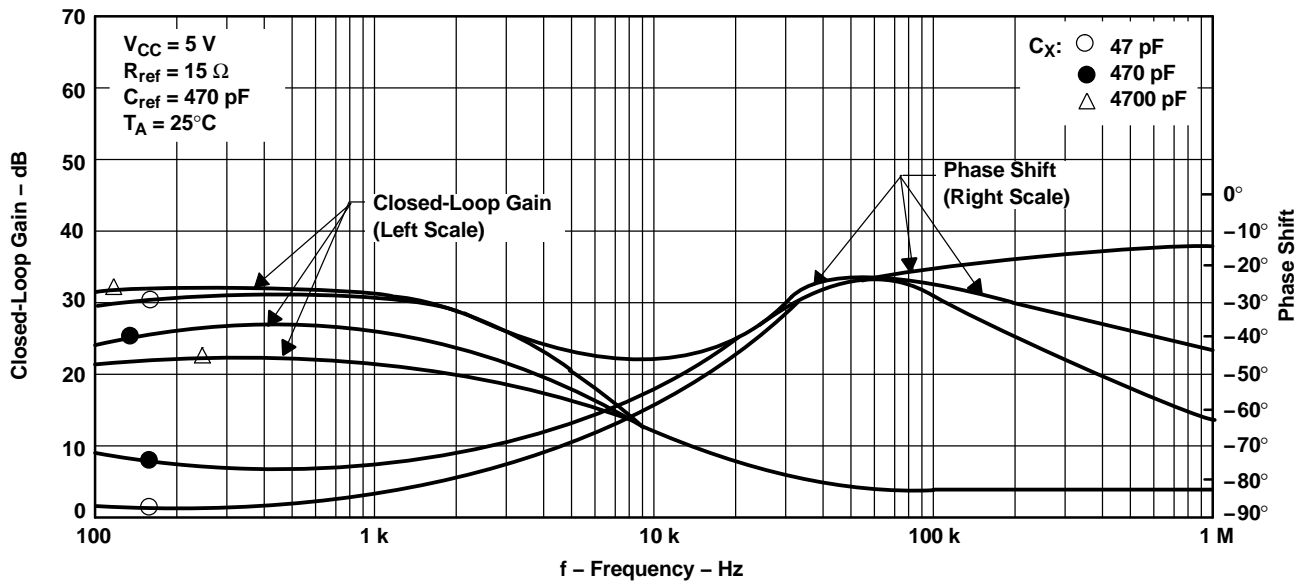

Test Circuit

Figure 21. Closed-Loop Gain and Phase Shift vs Frequency

TYPICAL CHARACTERISTICS (continued)

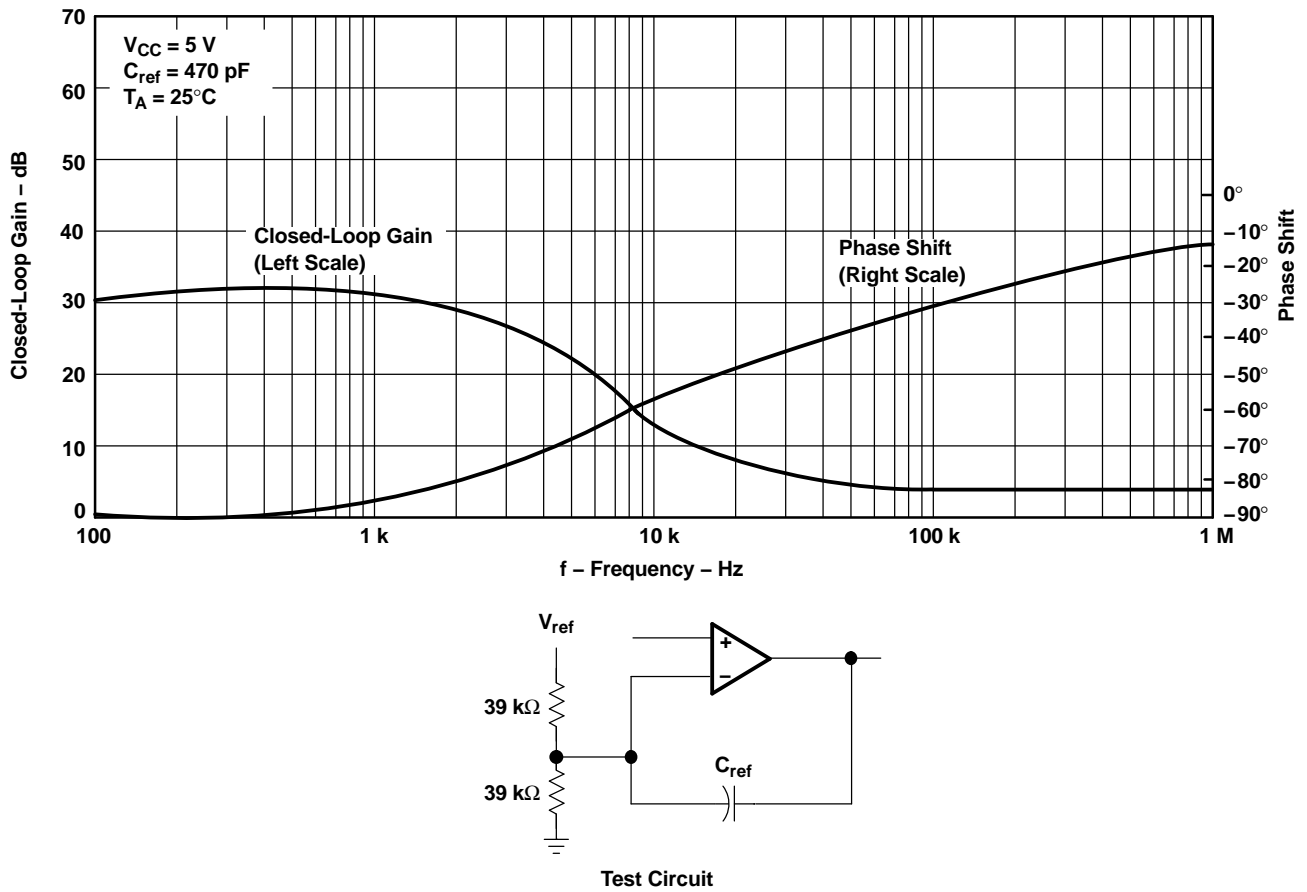

Figure 22. Closed-Loop Gain and Phase Shift vs Frequency

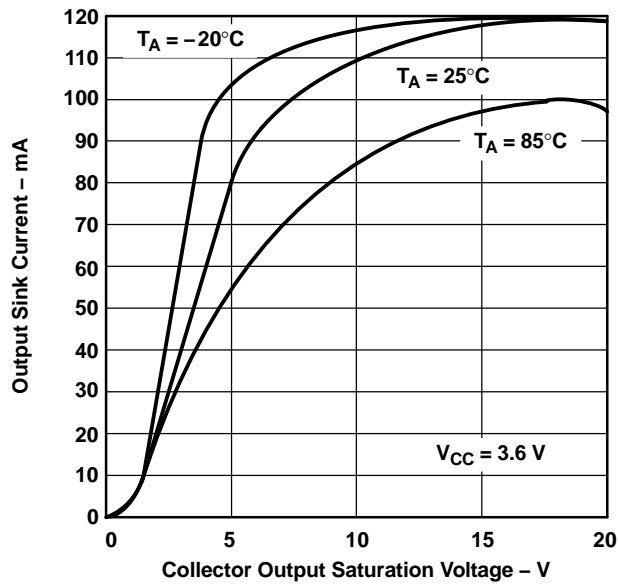

Figure 23. Output Sink Current vs Collector Output Saturation Voltage



TYPICAL CHARACTERISTICS (continued)

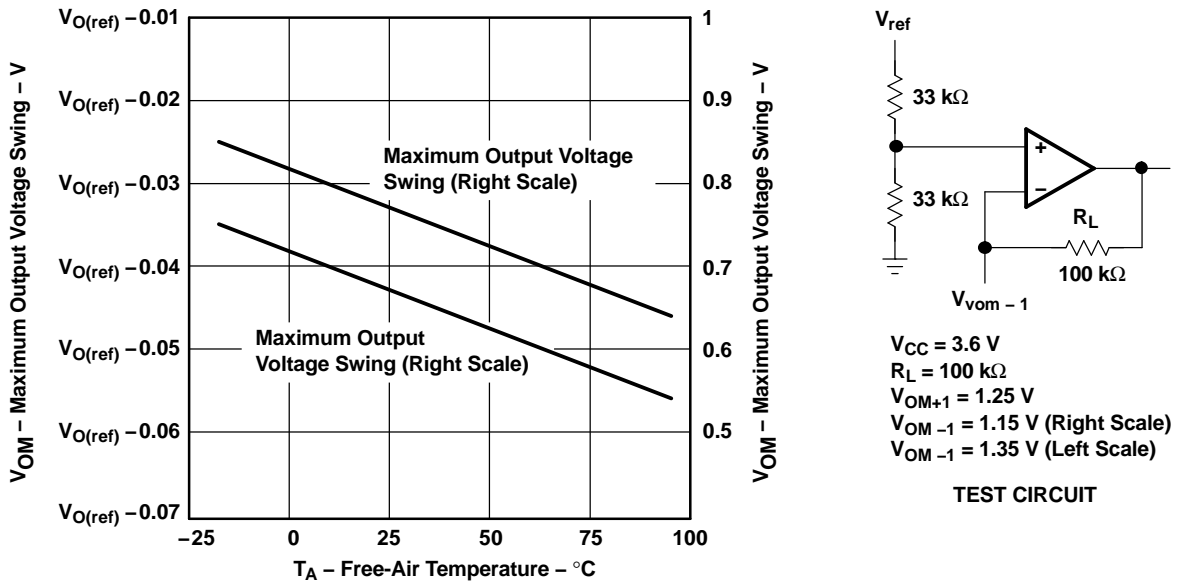

Figure 24. Maximum Output Voltage Swing vs Free-Air Temperature

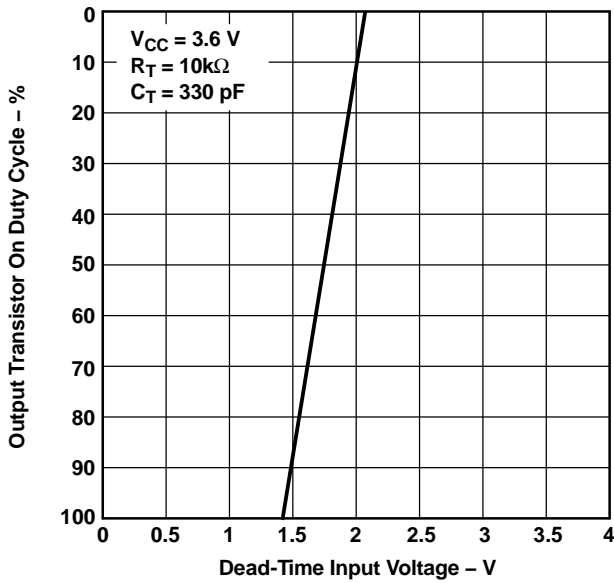

Figure 25. Output Transistor On Duty Cycle vs Dead-Time Input Voltage

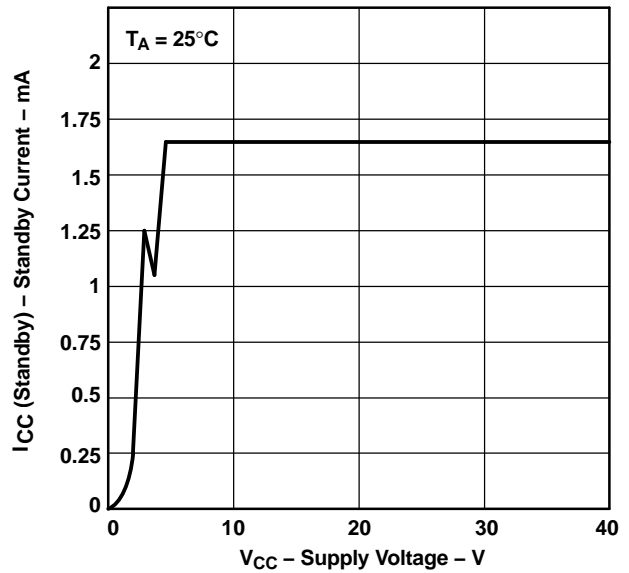

Figure 26. Standby Current vs Supply Voltage

TYPICAL CHARACTERISTICS (continued)

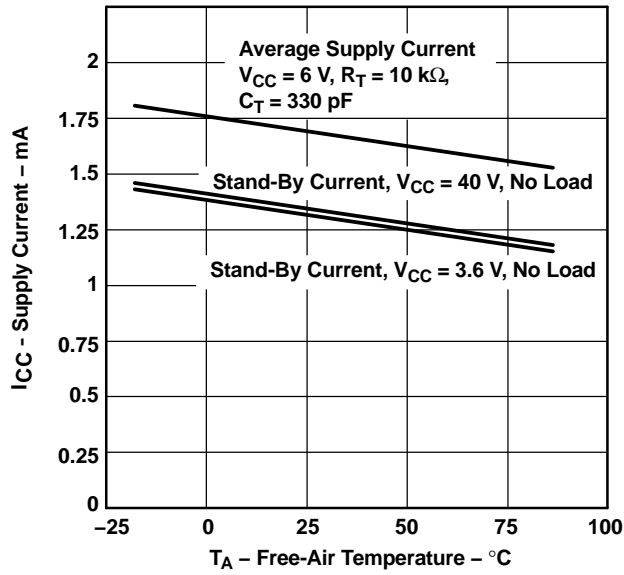

Figure 27. Standby Current vs Free-Air Temperature

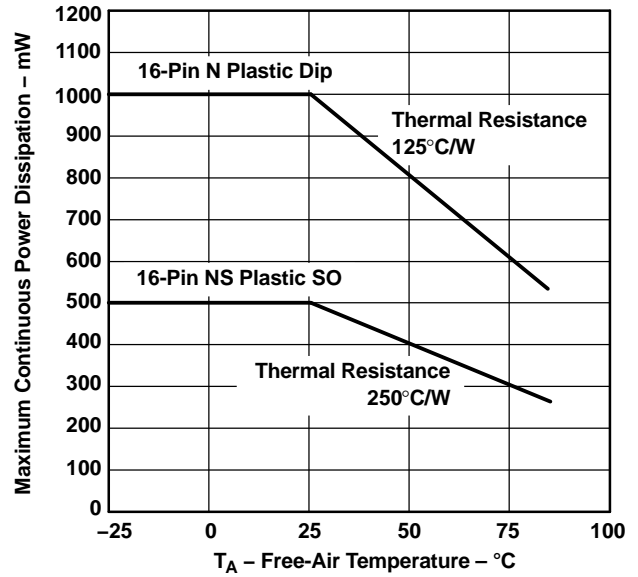
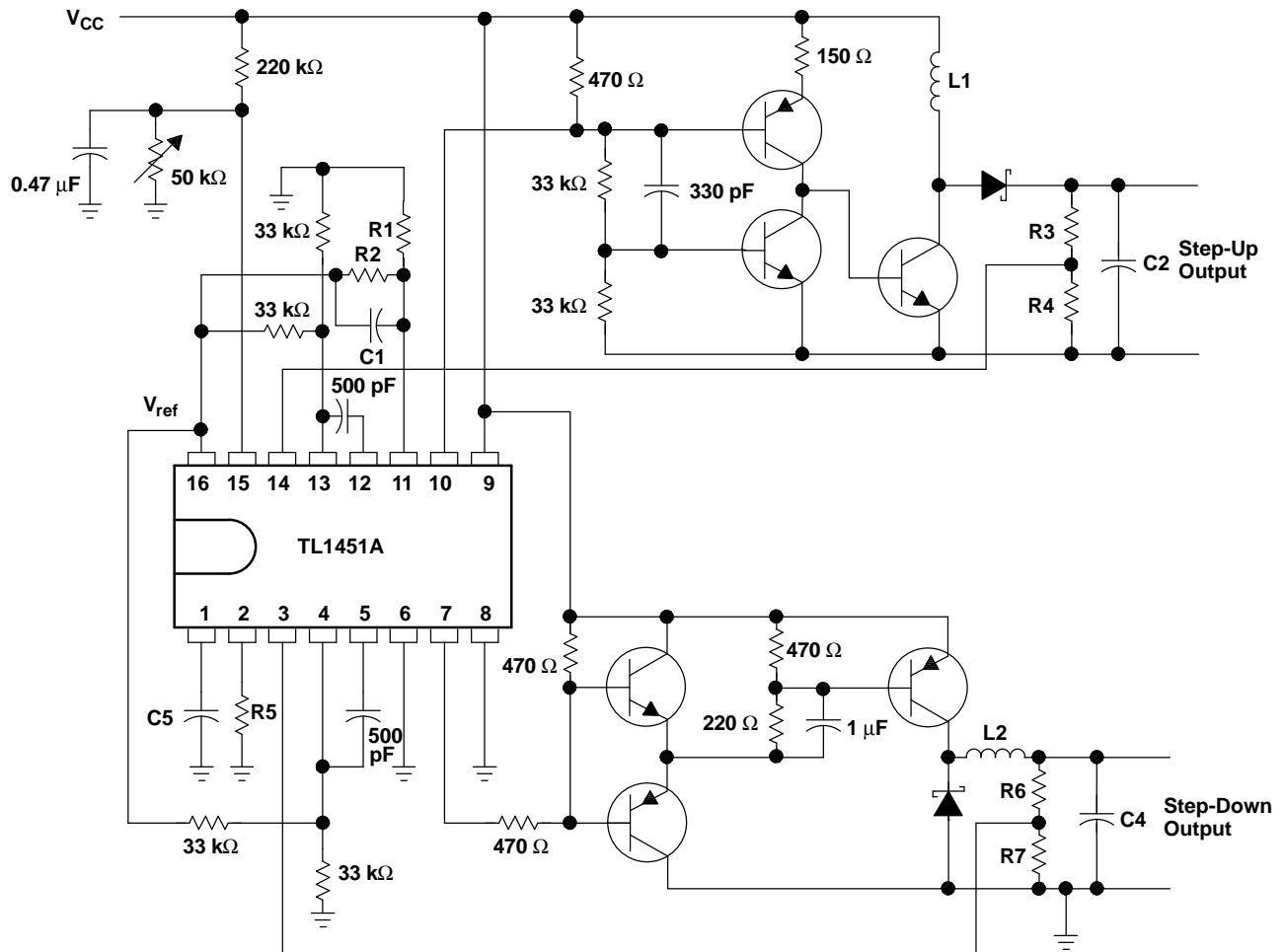

Figure 28. Maximum Continuous Power Dissipation vs Free-Air Temperature

**APPLICATION INFORMATION**



**Figure 29. High-Speed Dual Switching Regulator**

**PACKAGING INFORMATION**

Orderable Device	Status <sup>(1)</sup>	Package Type	Package Drawing	Pins	Package Qty	Eco Plan <sup>(2)</sup>	Lead/Ball Finish	MSL Peak Temp <sup>(3)</sup>
TL1451AMDREP	ACTIVE	SOIC	D	16	2500	Green (RoHS & no Sb/Br)	CU NIPDAU	Level-1-260C-UNLIM
V62/06611-01XE	ACTIVE	SOIC	D	16	2500	Green (RoHS & no Sb/Br)	CU NIPDAU	Level-1-260C-UNLIM

<sup>(1)</sup> The marketing status values are defined as follows:

**ACTIVE:** Product device recommended for new designs.

**LIFEBUY:** TI has announced that the device will be discontinued, and a lifetime-buy period is in effect.

**NRND:** Not recommended for new designs. Device is in production to support existing customers, but TI does not recommend using this part in a new design.

**PREVIEW:** Device has been announced but is not in production. Samples may or may not be available.

**OBsolete:** TI has discontinued the production of the device.

<sup>(2)</sup> Eco Plan - The planned eco-friendly classification: Pb-Free (RoHS), Pb-Free (RoHS Exempt), or Green (RoHS & no Sb/Br) - please check <http://www.ti.com/productcontent> for the latest availability information and additional product content details.

**TBD:** The Pb-Free/Green conversion plan has not been defined.

**Pb-Free (RoHS):** TI's terms "Lead-Free" or "Pb-Free" mean semiconductor products that are compatible with the current RoHS requirements for all 6 substances, including the requirement that lead not exceed 0.1% by weight in homogeneous materials. Where designed to be soldered at high temperatures, TI Pb-Free products are suitable for use in specified lead-free processes.

**Pb-Free (RoHS Exempt):** This component has a RoHS exemption for either 1) lead-based flip-chip solder bumps used between the die and package, or 2) lead-based die adhesive used between the die and leadframe. The component is otherwise considered Pb-Free (RoHS compatible) as defined above.

**Green (RoHS & no Sb/Br):** TI defines "Green" to mean Pb-Free (RoHS compatible), and free of Bromine (Br) and Antimony (Sb) based flame retardants (Br or Sb do not exceed 0.1% by weight in homogeneous material)

<sup>(3)</sup> MSL, Peak Temp. -- The Moisture Sensitivity Level rating according to the JEDEC industry standard classifications, and peak solder temperature.

**Important Information and Disclaimer:**The information provided on this page represents TI's knowledge and belief as of the date that it is provided. TI bases its knowledge and belief on information provided by third parties, and makes no representation or warranty as to the accuracy of such information. Efforts are underway to better integrate information from third parties. TI has taken and continues to take reasonable steps to provide representative and accurate information but may not have conducted destructive testing or chemical analysis on incoming materials and chemicals. TI and TI suppliers consider certain information to be proprietary, and thus CAS numbers and other limited information may not be available for release.

In no event shall TI's liability arising out of such information exceed the total purchase price of the TI part(s) at issue in this document sold by TI to Customer on an annual basis.

**OTHER QUALIFIED VERSIONS OF TL1451A-EP :**

- Catalog: [TL1451A](#)
- Automotive: [TL1451A-Q1](#)
- Military: [TL1451AM](#)

NOTE: Qualified Version Definitions:

- Catalog - TI's standard catalog product
- Automotive - Q100 devices qualified for high-reliability automotive applications targeting zero defects
- Military - QML certified for Military and Defense Applications

**TAPE AND REEL INFORMATION**

**REEL DIMENSIONS**

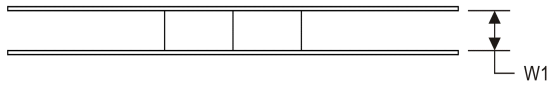

**TAPE DIMENSIONS**

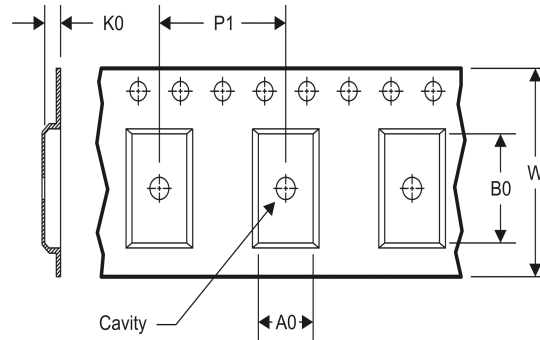

A0	Dimension designed to accommodate the component width
B0	Dimension designed to accommodate the component length
K0	Dimension designed to accommodate the component thickness
W	Overall width of the carrier tape
P1	Pitch between successive cavity centers

**TAPE AND REEL INFORMATION**

\*All dimensions are nominal

Device	Package Type	Package Drawing	Pins	SPQ	Reel Diameter (mm)	Reel Width W1 (mm)	A0 (mm)	B0 (mm)	K0 (mm)	P1 (mm)	W (mm)	Pin1 Quadrant
TL1451AMDREP	SOIC	D	16	2500	330.0	16.4	6.5	10.3	2.1	8.0	16.0	Q1

TAPE AND REEL BOX DIMENSIONS



\*All dimensions are nominal

Device	Package Type	Package Drawing	Pins	SPQ	Length (mm)	Width (mm)	Height (mm)
TL1451AMDREP	SOIC	D	16	2500	367.0	367.0	38.0

D (R-PDSO-G16)

PLASTIC SMALL OUTLINE



- NOTES:
- A. All linear dimensions are in inches (millimeters).
  - B. This drawing is subject to change without notice.
  - C. Body length does not include mold flash, protrusions, or gate burrs. Mold flash, protrusions, or gate burrs shall not exceed 0.006 (0,15) each side.
  - D. Body width does not include interlead flash. Interlead flash shall not exceed 0.017 (0,43) each side.
  - E. Reference JEDEC MS-012 variation AC.

D (R-PDSO-G16)

PLASTIC SMALL OUTLINE

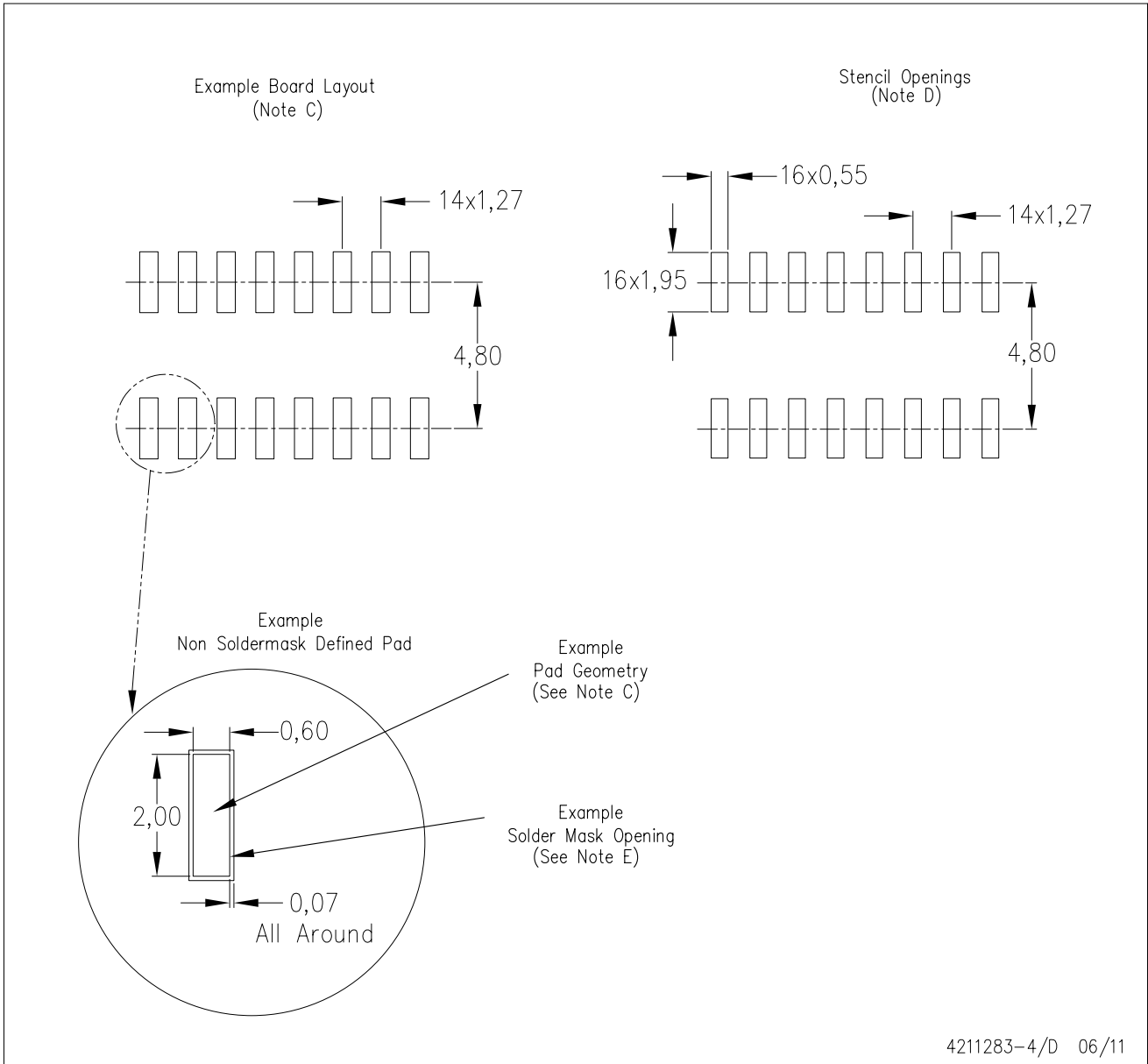

- NOTES:
- All linear dimensions are in millimeters.
  - This drawing is subject to change without notice.
  - Publication IPC-7351 is recommended for alternate designs.
  - Laser cutting apertures with trapezoidal walls and also rounding corners will offer better paste release. Customers should contact their board assembly site for stencil design recommendations. Refer to IPC-7525 for other stencil recommendations.
  - Customers should contact their board fabrication site for solder mask tolerances between and around signal pads.



## IMPORTANT NOTICE

Texas Instruments Incorporated and its subsidiaries (TI) reserve the right to make corrections, enhancements, improvements and other changes to its semiconductor products and services per JESD46C and to discontinue any product or service per JESD48B. Buyers should obtain the latest relevant information before placing orders and should verify that such information is current and complete. All semiconductor products (also referred to herein as "components") are sold subject to TI's terms and conditions of sale supplied at the time of order acknowledgment.

TI warrants performance of its components to the specifications applicable at the time of sale, in accordance with the warranty in TI's terms and conditions of sale of semiconductor products. Testing and other quality control techniques are used to the extent TI deems necessary to support this warranty. Except where mandated by applicable law, testing of all parameters of each component is not necessarily performed.

TI assumes no liability for applications assistance or the design of Buyers' products. Buyers are responsible for their products and applications using TI components. To minimize the risks associated with Buyers' products and applications, Buyers should provide adequate design and operating safeguards.

TI does not warrant or represent that any license, either express or implied, is granted under any patent right, copyright, mask work right, or other intellectual property right relating to any combination, machine, or process in which TI components or services are used. Information published by TI regarding third-party products or services does not constitute a license to use such products or services or a warranty or endorsement thereof. Use of such information may require a license from a third party under the patents or other intellectual property of the third party, or a license from TI under the patents or other intellectual property of TI.

Reproduction of significant portions of TI information in TI data books or data sheets is permissible only if reproduction is without alteration and is accompanied by all associated warranties, conditions, limitations, and notices. TI is not responsible or liable for such altered documentation. Information of third parties may be subject to additional restrictions.

Resale of TI components or services with statements different from or beyond the parameters stated by TI for that component or service voids all express and any implied warranties for the associated TI component or service and is an unfair and deceptive business practice. TI is not responsible or liable for any such statements.

Buyer acknowledges and agrees that it is solely responsible for compliance with all legal, regulatory and safety-related requirements concerning its products, and any use of TI components in its applications, notwithstanding any applications-related information or support that may be provided by TI. Buyer represents and agrees that it has all the necessary expertise to create and implement safeguards which anticipate dangerous consequences of failures, monitor failures and their consequences, lessen the likelihood of failures that might cause harm and take appropriate remedial actions. Buyer will fully indemnify TI and its representatives against any damages arising out of the use of any TI components in safety-critical applications.

In some cases, TI components may be promoted specifically to facilitate safety-related applications. With such components, TI's goal is to help enable customers to design and create their own end-product solutions that meet applicable functional safety standards and requirements. Nonetheless, such components are subject to these terms.

No TI components are authorized for use in FDA Class III (or similar life-critical medical equipment) unless authorized officers of the parties have executed a special agreement specifically governing such use.

Only those TI components which TI has specifically designated as military grade or "enhanced plastic" are designed and intended for use in military/aerospace applications or environments. Buyer acknowledges and agrees that any military or aerospace use of TI components which have **not** been so designated is solely at the Buyer's risk, and that Buyer is solely responsible for compliance with all legal and regulatory requirements in connection with such use.

TI has specifically designated certain components which meet ISO/TS16949 requirements, mainly for automotive use. Components which have not been so designated are neither designed nor intended for automotive use; and TI will not be responsible for any failure of such components to meet such requirements.

### Products

Audio	<a href="http://www.ti.com/audio">www.ti.com/audio</a>
Amplifiers	<a href="http://amplifier.ti.com">amplifier.ti.com</a>
Data Converters	<a href="http://dataconverter.ti.com">dataconverter.ti.com</a>
DLP® Products	<a href="http://www.dlp.com">www.dlp.com</a>
DSP	<a href="http://dsp.ti.com">dsp.ti.com</a>
Clocks and Timers	<a href="http://www.ti.com/clocks">www.ti.com/clocks</a>
Interface	<a href="http://interface.ti.com">interface.ti.com</a>
Logic	<a href="http://logic.ti.com">logic.ti.com</a>
Power Mgmt	<a href="http://power.ti.com">power.ti.com</a>
Microcontrollers	<a href="http://microcontroller.ti.com">microcontroller.ti.com</a>
RFID	<a href="http://www.ti-rfid.com">www.ti-rfid.com</a>
OMAP Mobile Processors	<a href="http://www.ti.com/omap">www.ti.com/omap</a>
Wireless Connectivity	<a href="http://www.ti.com/wirelessconnectivity">www.ti.com/wirelessconnectivity</a>

### Applications

Automotive and Transportation	<a href="http://www.ti.com/automotive">www.ti.com/automotive</a>
Communications and Telecom	<a href="http://www.ti.com/communications">www.ti.com/communications</a>
Computers and Peripherals	<a href="http://www.ti.com/computers">www.ti.com/computers</a>
Consumer Electronics	<a href="http://www.ti.com/consumer-apps">www.ti.com/consumer-apps</a>
Energy and Lighting	<a href="http://www.ti.com/energy">www.ti.com/energy</a>
Industrial	<a href="http://www.ti.com/industrial">www.ti.com/industrial</a>
Medical	<a href="http://www.ti.com/medical">www.ti.com/medical</a>
Security	<a href="http://www.ti.com/security">www.ti.com/security</a>
Space, Avionics and Defense	<a href="http://www.ti.com/space-avionics-defense">www.ti.com/space-avionics-defense</a>
Video and Imaging	<a href="http://www.ti.com/video">www.ti.com/video</a>

**TI E2E Community** [e2e.ti.com](http://e2e.ti.com)